



# WATER SOLUTIONS

## RAINWATER MANAGEMENT SYSTEMS



**DRENING**



**DRAINPANEL**



**AQUABOX**



**ELEVATOR TANK**

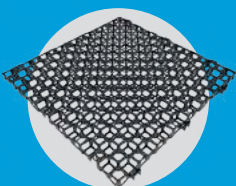

**GEOCELL**

- ✓ **RESISTANT**
- ✓ **MODULAR**
- ✓ **SUSTAINABLE**

# THE COMPANY



## HISTORY

Since its foundation in the early 1970s, Geoplast has been designing and manufacturing innovative recycled plastic products. We create sustainable solutions with high added value that offer excellent performance and a useful life cycle in line with construction industry standards.

Year after year we have improved our expertise in the strategic sectors in which we operate such as construction, stormwater management, urban green and landscape, always distinguishing ourselves as a reliable and efficient partner.

Geoplast products are available worldwide thanks to an extensive network of distributors, including two subsidiaries in South Africa and the USA.

## MANUFACTURING

- 3 plants covering a total area of 40.000 m<sup>2</sup>, 10,000 m<sup>2</sup> of which are roofed;
- 27 production lines: 2 plastic regeneration lines and 25 high-tonnage injection moulding machines;
- more than 20 million items produced per year;
- annual processing capacity of more than 25.000 tonnes of material.



# OUR KNOW-HOW

## SUSTAINABILITY

We at Geoplast firmly believe that the environment and industry can coexist and support each other. This has been our main motivation since the foundation of the of the company.

Almost all of our products are made from recycled plastic from post-consumer and industrial scrap: this way waste material is transformed into a valuable resource and ultimately into into new, intelligent applications.



## SERVICES & CONSULTING

The requirements of clients, designers and companies are supported by the technical expertise of a dedicated team of skilled specialists.

The services provided by Geoplast range from assistance on site, technical feasibility analyses, preliminary and executive plans.

Knowledge sharing and distribution are essential, and take the form of digital tools, webinars and publications.



## INNOVATION

A team of 10 engineers dedicated to the research and development of new solutions and materials has produced over 40 patents registered worldwide, as well as more than 50 trademarks.

Geoplast's philosophy is that there are always intelligent, sustainable and cost-effective solutions around the corner, and that it is up to us to discover them.

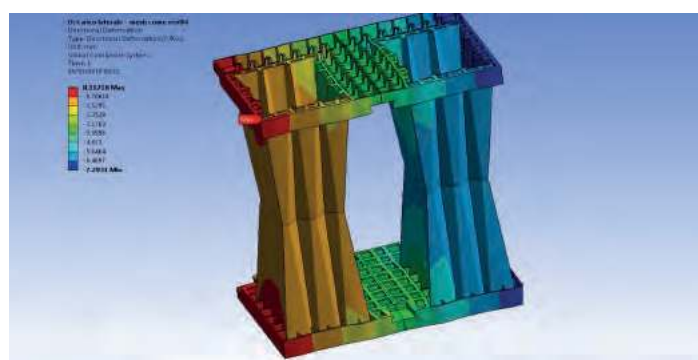

# CRITERIA TO BE CONSIDERED FOR INSTALLATION

In order for a rainwater infiltration/attenuation system to be sustainable in economic, environmental and social terms, it is essential to consider three aspects when choosing the product.

- 1 WATER TABLE** With the support of a geologist, check the depth of the water table to assess the complexity of the excavation and earthworks.
- 2 AVAILABLE SURFACE** Check what surface area is available in the area concerned, verify whether there are structural constraints, buildings, etc.
- 3 APPLIED LOAD** Third aspect is the load class applied to the system: it is necessary to make sure that the requirements of the system meet the norms and regulations in force in the country or area where the installation will take place.

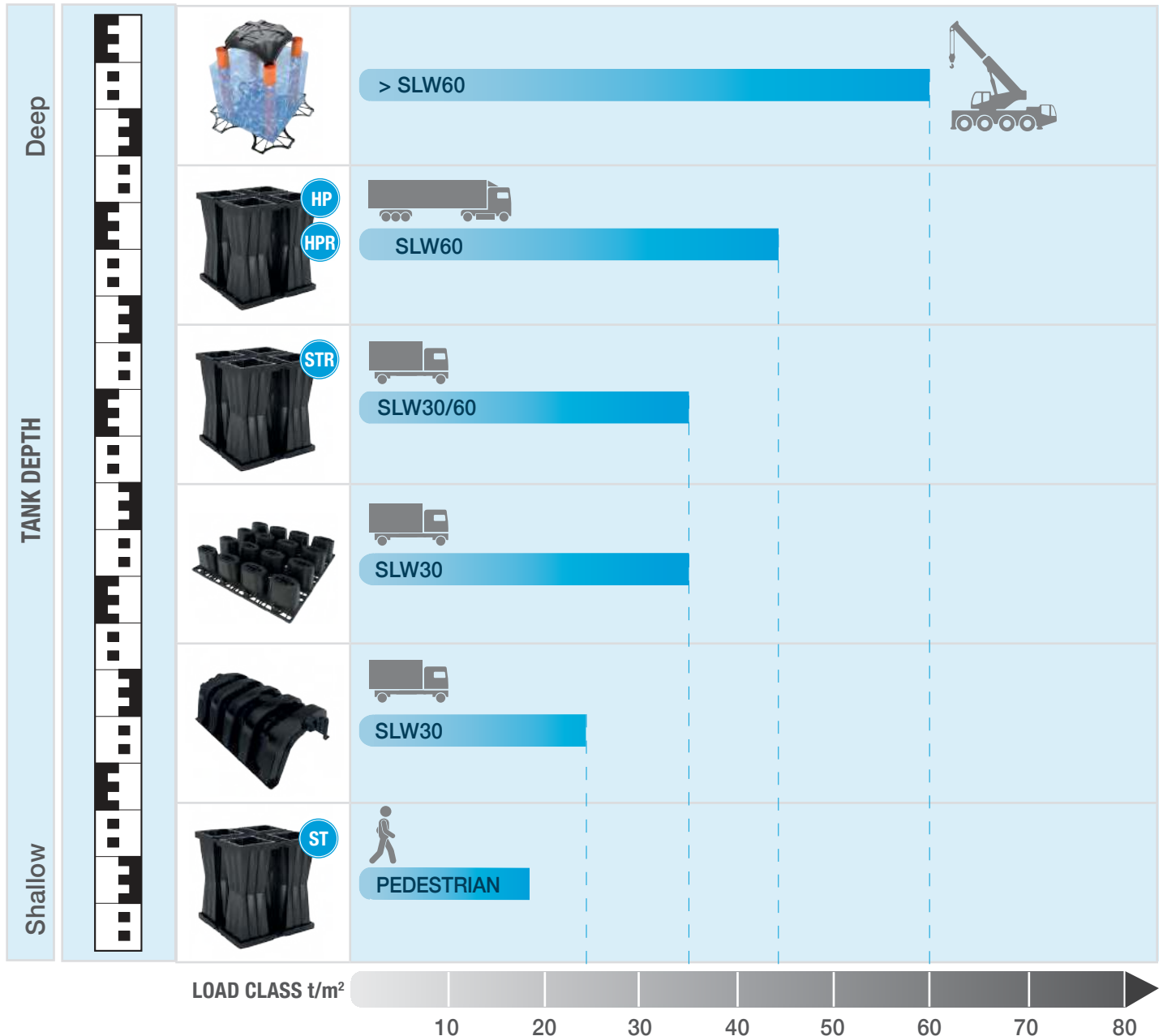

# INDEX

## RAINWATER MANAGEMENT SYSTEMS



DRENING

8



DRAINPANEL

20



AQUABOX

30



ELEVETOR TANK

54



GEOCELL

68

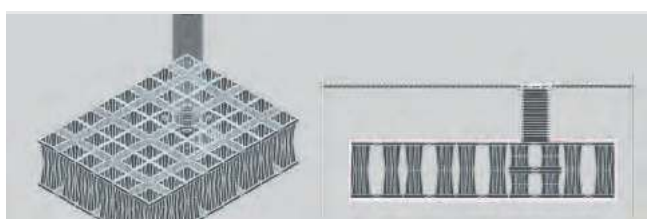

TECHNICAL DATA

78

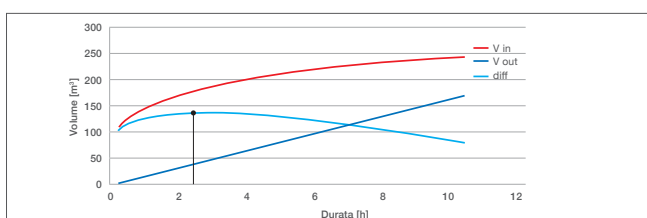

TANK DIMENSIONING

84



### DRENING

Tunnel element for water retention and infiltration.



### ELEVATOR TANK

Permanent formwork for high-performance reinforced concrete water tanks.



### DRAINPANEL

Stormwater infiltration and attenuation modules.

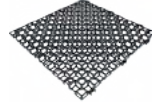

### GEOCELL

Cellular structural drainage panel with high horizontal flow capacity.



### AQUABOX

Geocellular stormwater management system.

GEOCELL

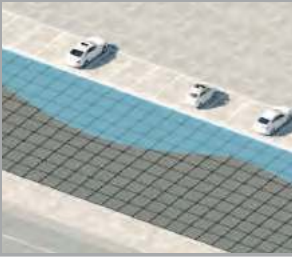

AQUABOX



DRAINPANEL

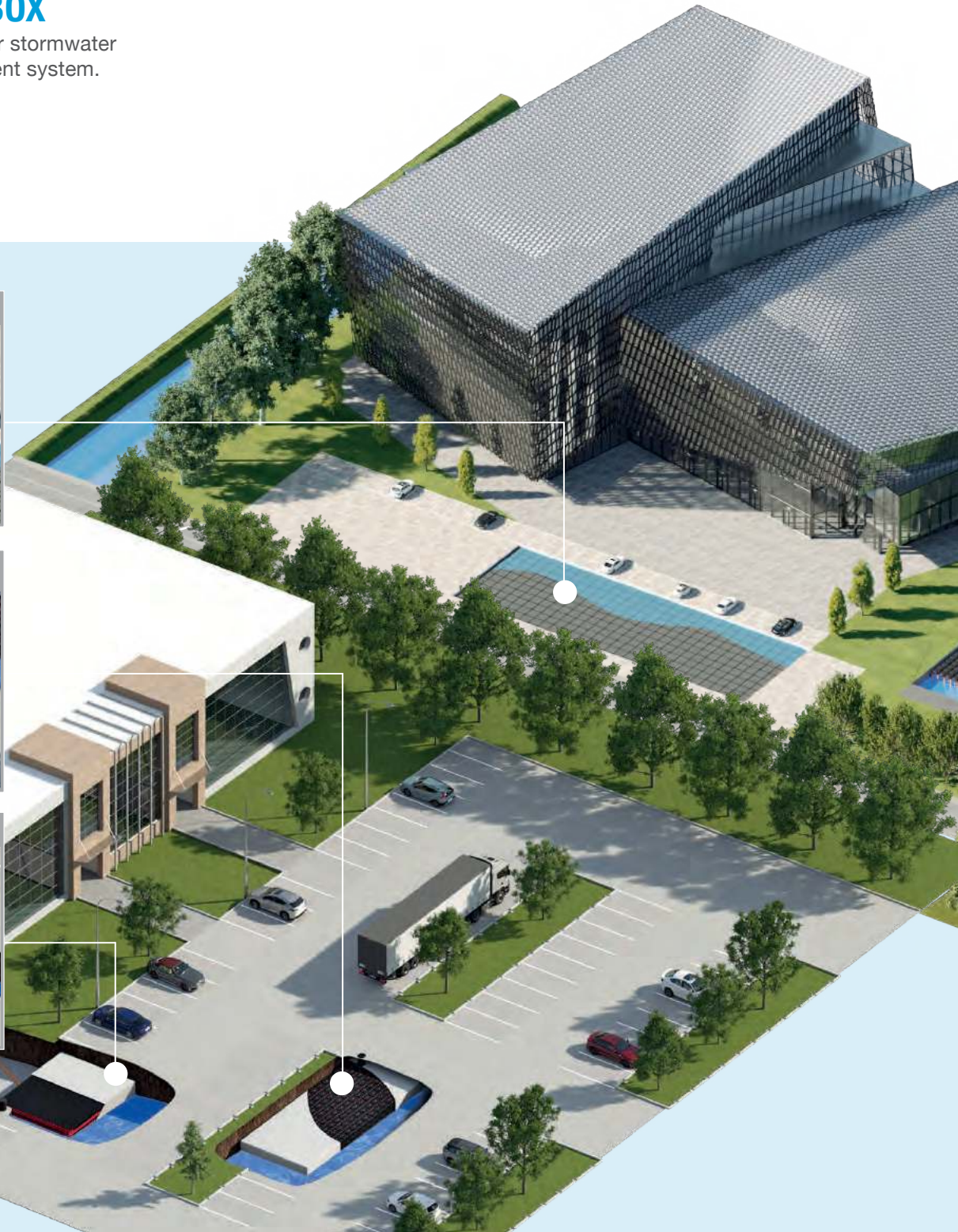

# CONCEPT

The increasing precipitations combined with the growth of urban impervious surfaces are highlighting the need of efficient and sustainable stormwater management solutions. Geoplast offers several such solutions, suitable for different specific requirements. In situ stormwater detention and its controlled release into the drainage system or watercourses

helps to mitigate the potential damage inflicted to local territory and urban areas during heavy rainfall events.

Geoplast has developed a wide range of solutions capable of responding to specific needs, based on project requirements.



# DRENING



- ✓ **EASY HANDLING**
- ✓ **STRONG**
- ✓ **HIGH DRAINAGE**

**TUNNEL ELEMENT  
FOR RAINWATER STORAGE  
AND DISPERSION**





# THE SOLUTION

Drening is a modular element made of regenerated polymer, designed to create underground tanks for in situ rainwater management.

Depending on the type of installation, Drening favours underground drainage by limiting surface flow. This prevents flooding and contributes to the recharge of groundwater tables; alternatively it allows the reuse of the collected water to save drinking water resources.

Drening can also be used for sub-irrigation of pre-treated wastewater from buildings not connected to the sewer system.

The material and structure of Drening have been studied specifically to create high-strength systems. The product can be placed under heavy-traffic areas, and requires a shallow excavation for a low-invasive installation operation.

## ATTENUATION TANKS

## STORMWATER DETENTION AND REUSE

## WASTEWATER INFILTRATION



# RESTORATION OF HYDROLOGICAL BALANCE

Drening is not simply a measure to prevent flooding but, by favouring the infiltration of water into the subsoil, it is a part of a wider system that aims to recharge the aquifers, one of the most exploited sources of water supply by man.

In this way the natural water balance is maintained, even in areas where the soil has been rendered impervious.



# ADVANTAGES



The Draining infiltration tunnel has been designed to be installed in areas with a large available infiltration area. The system consists of a succession of interconnected tunnels and a closing cap at the two ends of each row of elements. Installation is on one level only.

The basin must be sized according to the volume of rainwater to be disposed of, always taking into account the parameters that influence its calculation: the rainfall, the nature of the soil, the drainage surface and the loads applied.



## REDUCED EXCAVATION

It allows a low-depth, non-invasive operation, ideal in areas with a high water table.



## SIMPLE INSTALLATION

Thanks to its lightness, less than 10 kg per element, it can be handled manually without the need for recourse to mechanical means.



## UNIVERSAL SOLUTION

The most frequent applications are:

- at the outlet of an overflow for stormwater management tanks,
- as infiltration tank after a filtration system,
- at the outlet of a non-collective sewage system.

# DETAILS THAT MAKE THE DIFFERENCE



① Designed for connection of a ventilation channel or inspection point.



② Reinforced arch structure to provide resistance even to heavy loads.

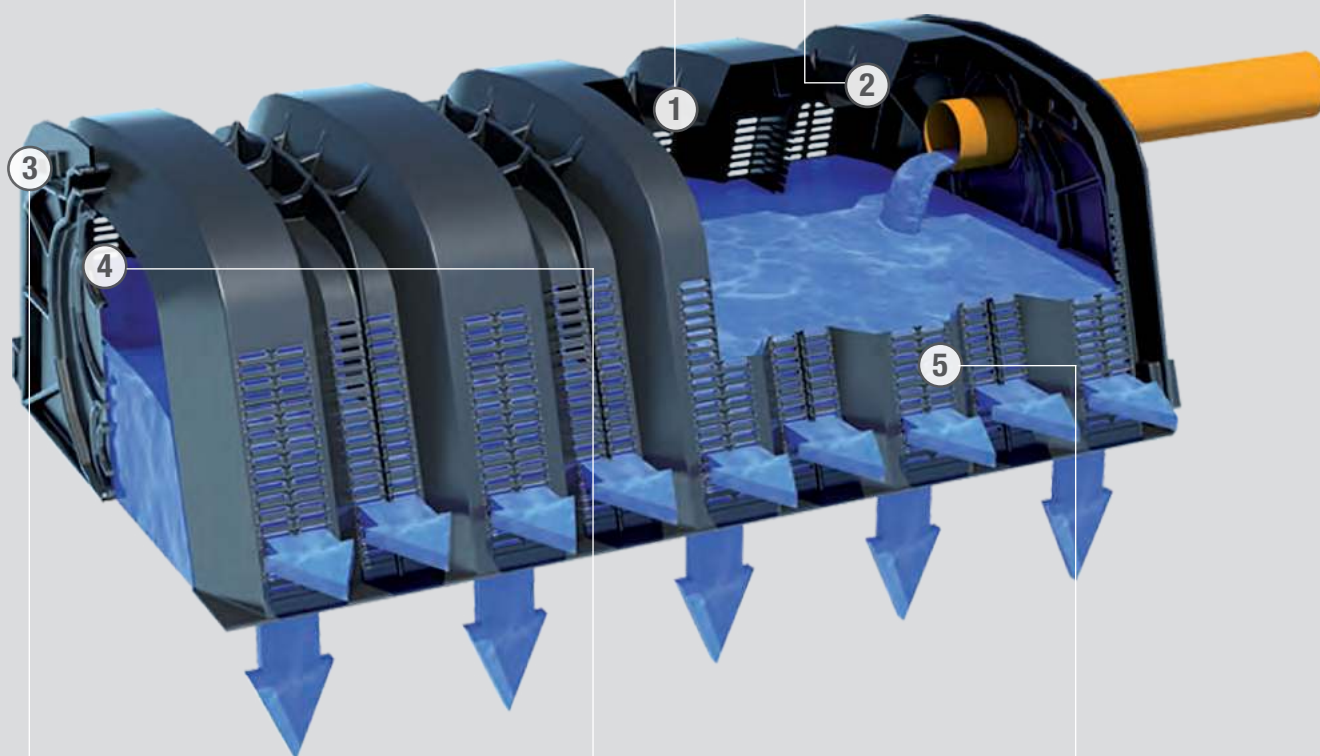

③ Drening Cap for simple fitting, suitable for pipes with DN from 60 mm to 320 mm, inserted at the base or the top.



④ Double overlapping hooking that allowing interlocking installation and a stable connection between the elements.



⑤ The base is completely open and side walls are slotted, creating an infiltration surface of 12.400 cm<sup>2</sup> per element.

# INSTALLATION

**LEGEND**

- (A)** Road surface
- (B)** Covering
- (C)** Geotextile
- (D)** Washed gravel 20/40 mm
- (E)** Drening
- (F)** Gravel (infiltration) Waterproofing (detention)
- (G)** Natural soil

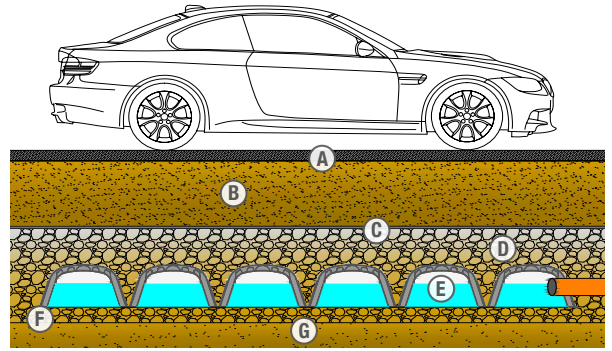

**① GRAVEL LAYING**

Construction excavation and laying of washed gravel 20-40 mm with thickness 10-15 cm.



**② INSTALLATION**

Manual installation of Drening (estimated speed: 1 element per minute).



**③ CONNECTIONS**

Closing of the system with the specific caps and insertion of the power source pipes and the overflow ones (if required by the project).



**④ COVERING**

Backfill of at least 30 cm and covering with washed gravel 20-40 mm for a minimum thickness of about 15 cm (this can change depending on the provided layer build-up).



**⑤ GEOTEXTILE**

Place a geotextile all over the contact surface between the gravel and the natural ground.



**⑥ FINISHING**

Finished surface (road, carpark or vegetated) as required by the project.

# DRENING APPLICABLE LOADS

Depending on the loads applied to the system, a minimum thickness must be provided to covering the Drening chambers.



**HS20** ✓

**HS25** ✓

**HS25** ✓

The recommended layer build-up depending from the applied loads are available in [Geoplastglobal.com](http://Geoplastglobal.com)  
In case of modification of the proposed cross-sections please contact the technical office of Geoplast Spa.



# INFILTRATION UNDER CAR PARKS

Drening is the ideal solution to deal with rainwater in car parks as it significantly reduces the water volume in the drainage system, facilitating the infiltration in the subsoil in order to prevent surface floods. The easy and fast installation allows to build also very large basins in a very short time.

In this way Drening is a very competitive solution compared to other traditional drainage systems.



# ROOFTOP RAINWATER INFILTRATION

Drening allows the construction of underground tanks to store efficiently and rapidly the water flowing from loading and unloading areas or from the roofs of industrial and commercial buildings.

Thanks to its high strength, Drening can also be installed under high traffic areas, such as manoeuvring yards and truck parks. Moreover, the modularity of the product adapts very well to the available surface.



# RESIDENTIAL DEVELOPMENTS

Drening is the low impact solution to prevent flooding in new developments and comply with local regulations on drainage in the storm drain network. It ensures optimal stormwater drainage and water management “on site”, avoiding the inconvenience and safety problems of an open water pond.

Drening adapts to all available surfaces, thanks to its modular structure, and allows for a less invasive intervention in terms of excavation.



# DRAINAGE OF ROAD INFRASTRUCTURES

Drening can be used to create drainage systems (roadside trenches, tanks under roundabouts) to quickly handle rainwater flowing from the roadway, avoiding traffic disruption.

Thanks to its compact size and quick installation, it is a very easy system to handle in the small spaces typical of road construction sites. The high resistance to loads allows installations even in areas subject to heavy traffic.



# DRENING AND PHYTODEPURATION

Drening can be used as a support element for slightly depressed vegetated trenches, placed on the edge of roads or car parks, into which rainwater is conveyed. In this way, the pollutants present in the runoff water are removed by means of phytodepurification and filter into the ground, and are then emptied and disposed of in the basin below.

In doing so, in addition to a quantitative management of rain flow rates, a cleaner water is returned to the environment.

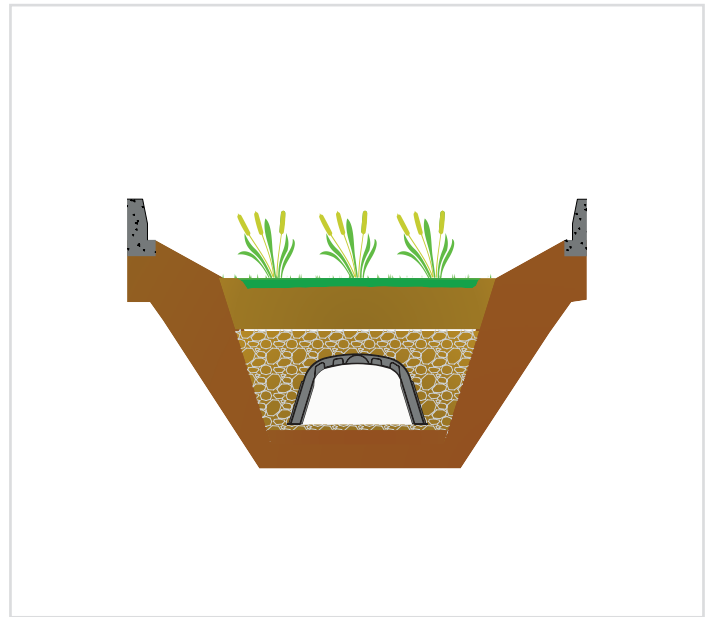

# RAINWATER DETENTION AND REUSE

By means of appropriate waterproofing to block dispersion into the subsoil, Drening makes it possible to create tanks used to collect rainwater drained from surfaces for irrigation.

In this way, in addition to solving drainage problems, whenever possible it also saves drinking water by replacing it with rainwater is a viable option.

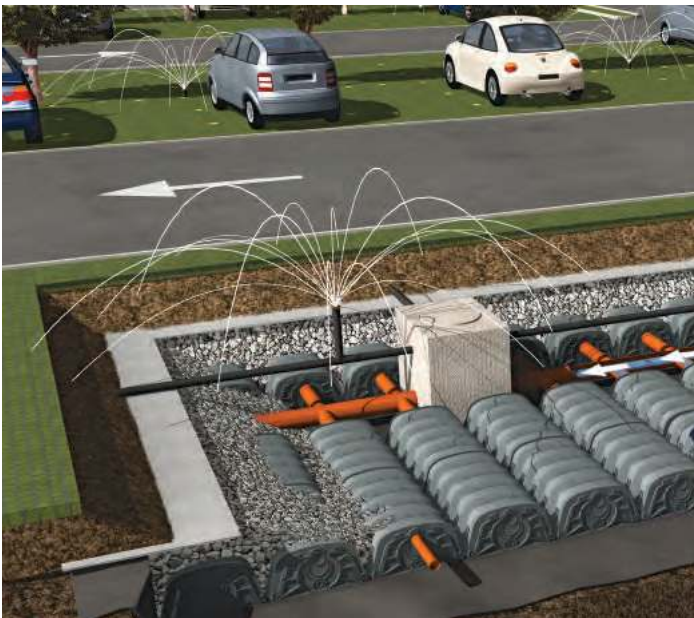



# DRENING REFLUE

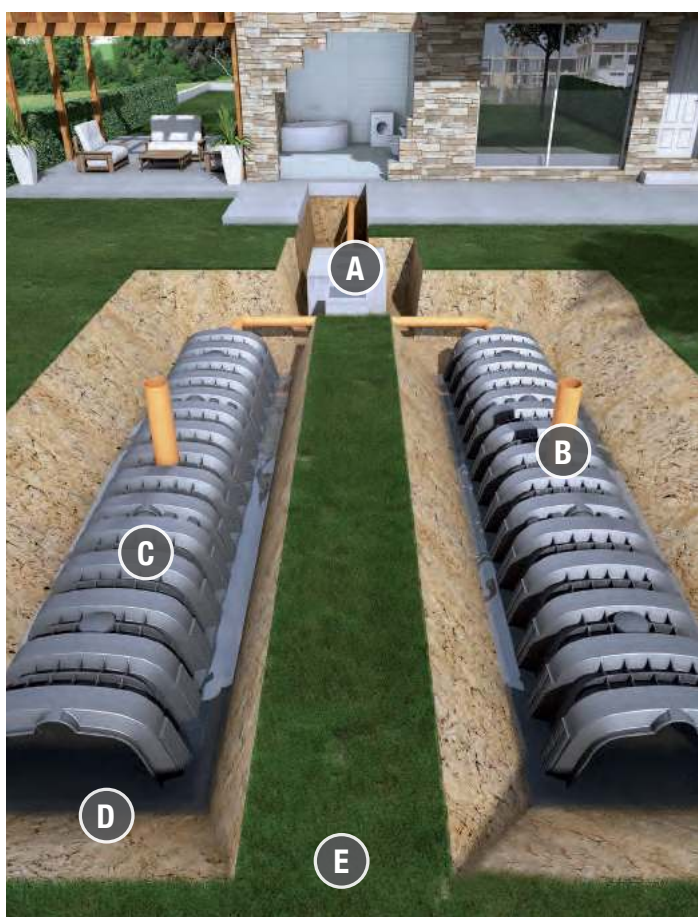

## DOMESTIC WASTEWATER INFILTRATION

Drening can also be used for the disposal by sub-irrigation of domestic waste water, after a purification treatment (septic tank), an ideal solution for residential settlements not connected to the sewerage network.

Installing a ventilation will prevent bad odours and cleaner water will be returned to the environment. Drening is also easier to clean and inspect than the traditionally used perforated tube.

### LEGEND

- (A)** Septic tank
- (B)** Ventilation
- (C)** Drening
- (D)** Infiltration
- (E)** Trench installation

# INSTALLATION



## ① EXCAVATION

Dig a trench at least 900 mm wide at the base.



## ③ INSTALLATION OF DRENING

Install the Drening chambers



## ⑤ LAYING OF GETOTEXTILE

Lay geotextile over the whole surface.

# VENTILATION

Ventilation of the system is essential to prevent the propagation of odours, as well as encouraging the purification of wastewater.

The absence of air, in fact, leads to anaerobic bacterial degradation of the organic matter present in the wastewater, which produces an unpleasant odour.



## ② SPREAD GRAVEL

Spread gravel 20/40 mm (minimum layer thickness 100 mm).



## ④ COVERING

Connect feeding and ventilation pipes.  
Cover with at least 150-200 mm of gravel 20/40 mm.



## ⑥ COMPLETE FILLING

Cover until the ground level has been reached.

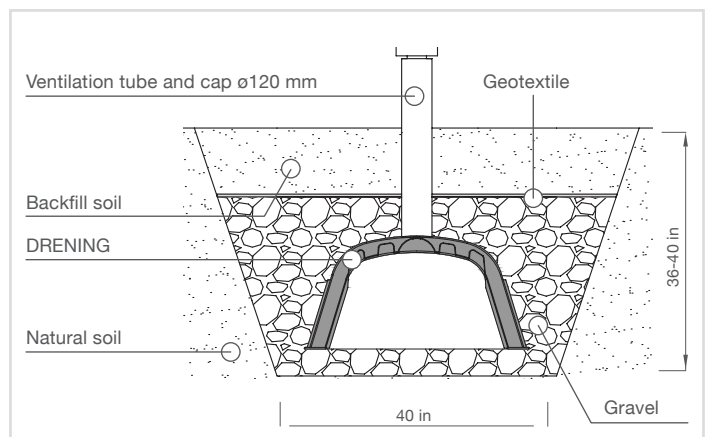

# DRENING REFLUE DIMENSIONING

Soil type	No. of Drening chamber per Population Equivalent*	Infiltration volume (l)	Infiltration surface (cm <sup>2</sup> )
Large sand or pebbles, or gravel, or mixed	1	300	12400
Fine sand	1,5	450	18600
Sand or gravel, or pebbles with limestone	2	600	24800
Clay or limestone with much sand, or pebbles	3	900	37200
Clay or limestone with little sand, or pebbles	6	1800	74400
Impervious compact clay	Not suitable	-	-

\*Equivalence of the individual pollution load in household sewage produced by one person in the same time, conventionally equivalent to a BOD of 60g of oxygen per day.

The number of Drening chambers that will compose the infiltration trench is obtained starting from the type of soil and the population equivalent that the system will serve.

To obtain this data it is sufficient to multiply the population equivalent by the coefficient in the table, based on the type of soil in which the trench will be installed.

## TYPICAL INSTALLATION DIAGRAM

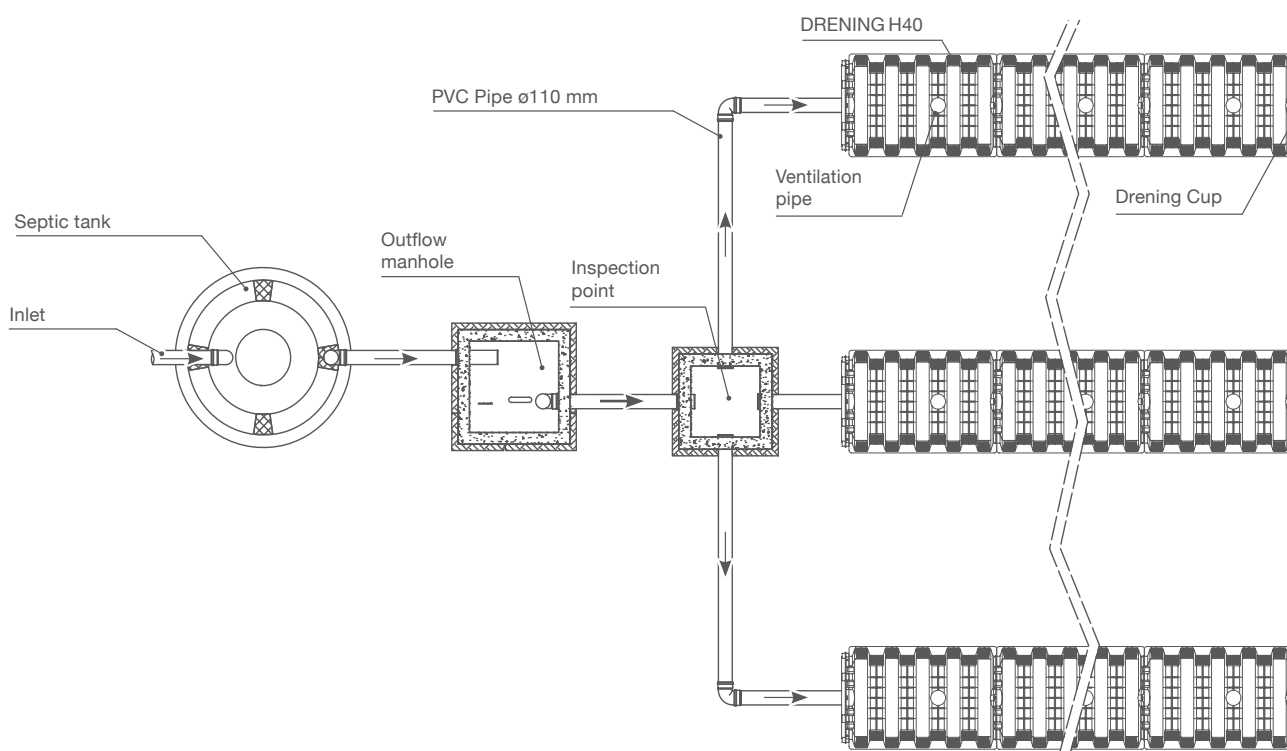

# DRAIN PANEL



## MODULAR ELEMENT FOR STORMWATER MANAGEMENT



# THE SOLUTION

Drainpanel is a modular element made of regenerated PP designed to create underground rainwater management tanks.

Drainpanel can be used to create an infiltration tank, releasing the water into the subsoil and then recharging aquifer. Its other applications are attenuation or detention tanks.

In the case of an infiltration tank, the system is wrapped in a geotextile, which allows water to seep into the ground. If the water has to be collected, the tank is wrapped in a waterproof geomembrane.

The Drainpanel elements are assembled by simple interlocking and stacking. The high mechanical strength of Drainpanel, allows the creation of tanks in high traffic areas.

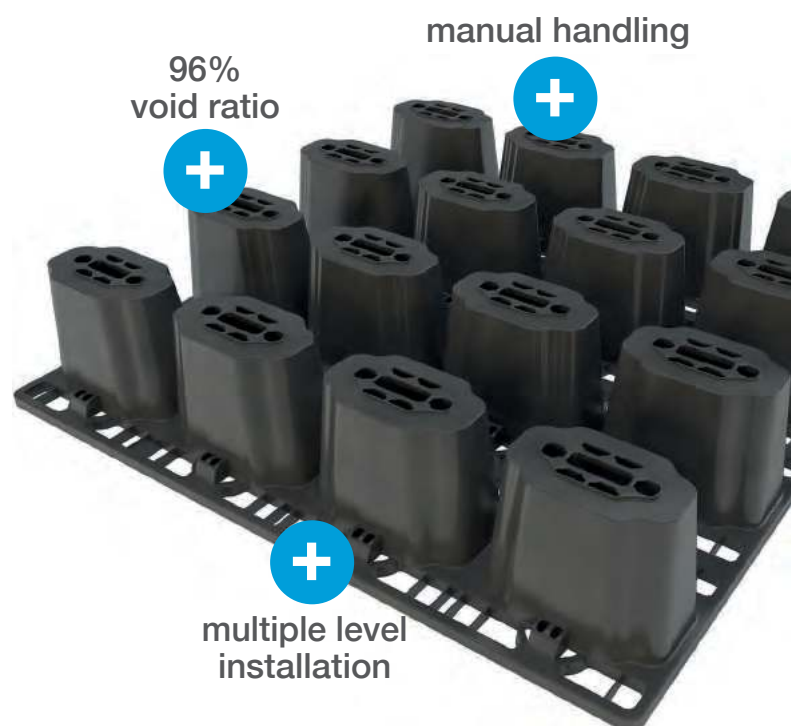

## INFILTRATION

## ATTENUATION

## RAINWATER DETENTION AND REUSE

## VOLUME

The Drainpanel element fitted on 4 levels offers a net water storage capacity of 963 litres, with a gross volume of more than one cubic metre. Designers and contractors prefer the Drainpanel over traditional methods (gravel and pipes) due to its very high storage density.

Each module consists of 16 hollow and perforated stubs that allow water to flow through the stack. If the inlet flow exceeds the discharge flow, the construction geometry of the element allows the water to rise slowly through the Drainpanel modules and then to be released gradually into the ground.



# ADVANTAGES



Drainpanel is a modular element for drainage, collection and reuse of rainwater. The modules are placed one atop the other on several levels without the use of any special connections or joints.

In order to meet the respective load classes of passenger cars, trucks and special vehicles, the basin will be dimensioned with variable height with a 200 mm pitch. This gives a very high degree of flexibility in design.



## FAST INSTALLATION

The installation of the product is completely manual, without need for mechanical handling. Installation can be carried out by a single operator as the weight of the modules is lower than the maximum liftable weight in optimal conditions (ISO 11228).



## STACKABLE ELEMENTS

The Drainpanel and Drainpanel Half elements engage with each other by simple interlocking, rotating the panels 90° with respect to the underlying layer.

The lateral connection follows the “brick” assembly technique, without any fixing system required (screws, glues/silicone, clips).



## LOAD- BEARING

Drainpanel was designed to withstand loads of heavy vehicles.

It can be installed on several levels to reach the design tank height.

# THE CONCEPT

## HIGH VOID-RATIO

Drainpanel is an alternative system to gravel in the construction of trenches or rainwater drainage tanks.

The structure of the panel gives a regular void volume 3 times greater than that of gravel (the truncated cone shaped elements are hollow inside and can be completely filled with water). In this way it is possible to create a high capacity tank, considerably limiting the volume of excavation.

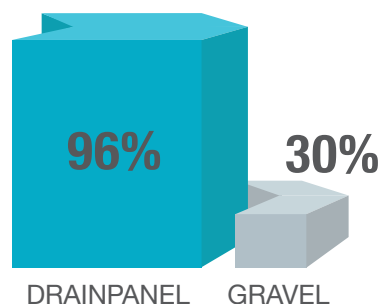

# LOAD CLASSES

Depending on the loads applied to the system, a minimum subsoil must be provided for the covering of the structure.



For detailed information on thickness and number of layers according in different load conditions please contact Geoplast Spa.

# DRAIN PANEL GRID

Element that allows the upper closure of the system to facilitate the laying of the geotextile or waterproofing membrane.



**3 grids per  
Drainpanel**

Dimensions: 112 x 28 cm  
Thickness: 3,8 cm  
Weight: 2 kg





# INFILTRATION

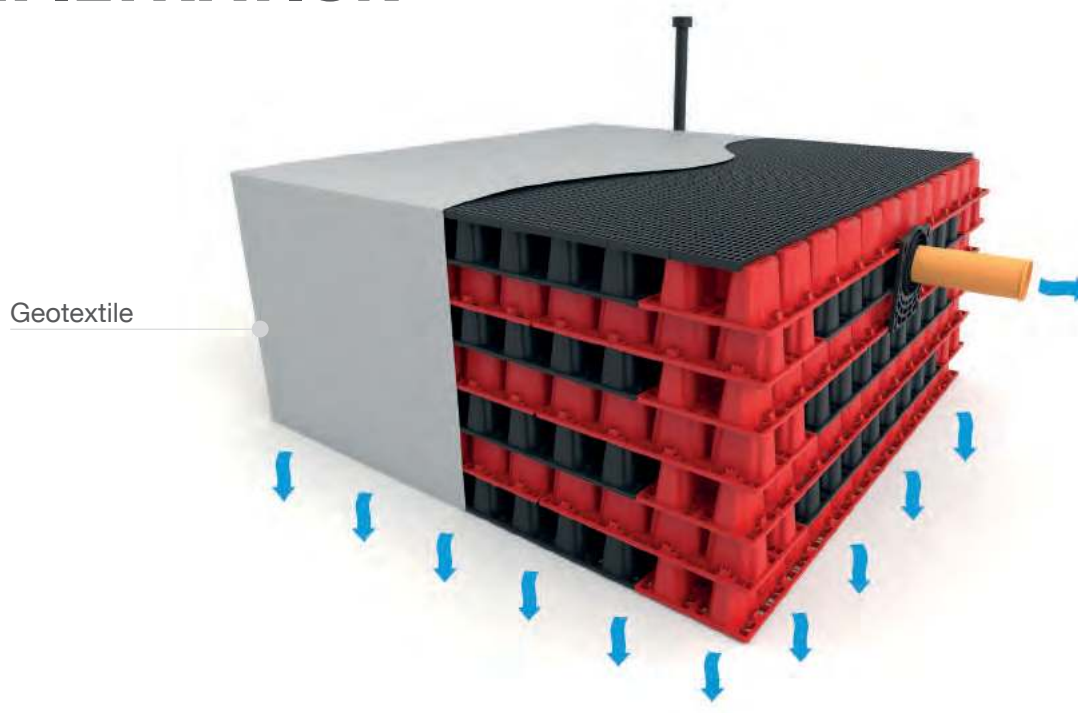

An infiltration basin made with the Drainpanel system offers a good solution to rainwater drainage, favouring its management on site and contributing to the restoration of the natural water cycle. The system gradually accumulates the inflowing water and releases it slowly into the soil, which must be highly permeable.

# ATTENUATION OR DETENTION FOR REUSE



Another application required by designers and hydraulic engineers are tanks for rainwater attenuation or detention and reuse.

In this case, after laying a first layer of geotextile, a waterproof membrane (second layer), protected on all sides by a geotextile (third layer), is laid. This creates a perfectly watertight tank capable of storing rainwater for reuse as desired.

# INFILTRATION

Drainpanel is the ideal solution for the construction of drainage tanks or of any depth.

The solid and robust structure gives the product a high resistance to loads, which allows it to be positioned even under trafficked areas.



# INFILTRATION

The high volume of voids obtained with Drainpanel makes it possible to minimise excavation volumes compared to traditional systems in which gravel is used.



# INFILTRATION

Drainpanel is the ideal solution for creating infiltration basins in both driveways and green areas.

The height of 200 mm per layer gives great flexibility in the design, allowing the depth to be modulated with great precision. This feature is useful in the case of shallow aquifer, allowing you to optimise the useful volume of the tank.



# ATTENUATION AND DETENTION

By lining the structure obtained with Drainpanel with a waterproof geomembrane, it is possible to create rainwater storage tanks for subsequent reuse. The shape of the elements allows them to be stacked in several layers, while ensuring a high load-bearing capacity. In addition, the high capacity of Drainpanel allows considerable accumulation in small spaces.



# INSTALLATION

## LEGEND

- (A) Natural soil
- (B) Foundation
- (C) Drainpanel system
- (D) Geotextile or Geomembrane
- (E) Backfill
- (F) Covering
- (G) Paved surface

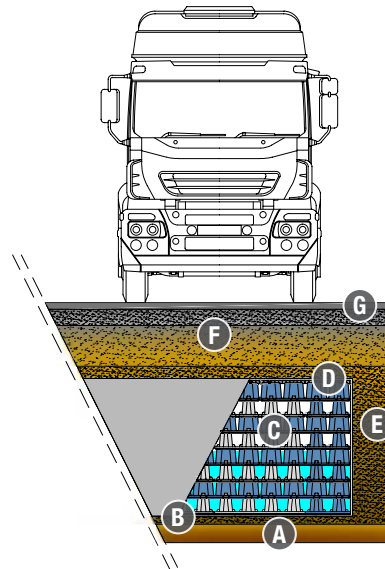

## 1 EXCAVATION

Excavate as per design.



## 2 PREPARATION

Place a layer of sand or fine gravel to adjust and level the bottom of the pit, then lay the geotextile.



## 3 INSTALLATION

Manually install the Drainpanel layers, then place the Drainpanel Grids over the topmost layer.



## 4 CONNECTION

Connect the feed and discharge pipes to the tank.



## 5 GEOTEXTILE

Wrap the sides and the top of the Drainpanel tank with geotextile.



## 6 FINISHING

Cover the tank with the layers as required by the design (paved or landscaped surface).

# LOGISTICS

## DRAINPANEL STORAGE AND TRANSPORT

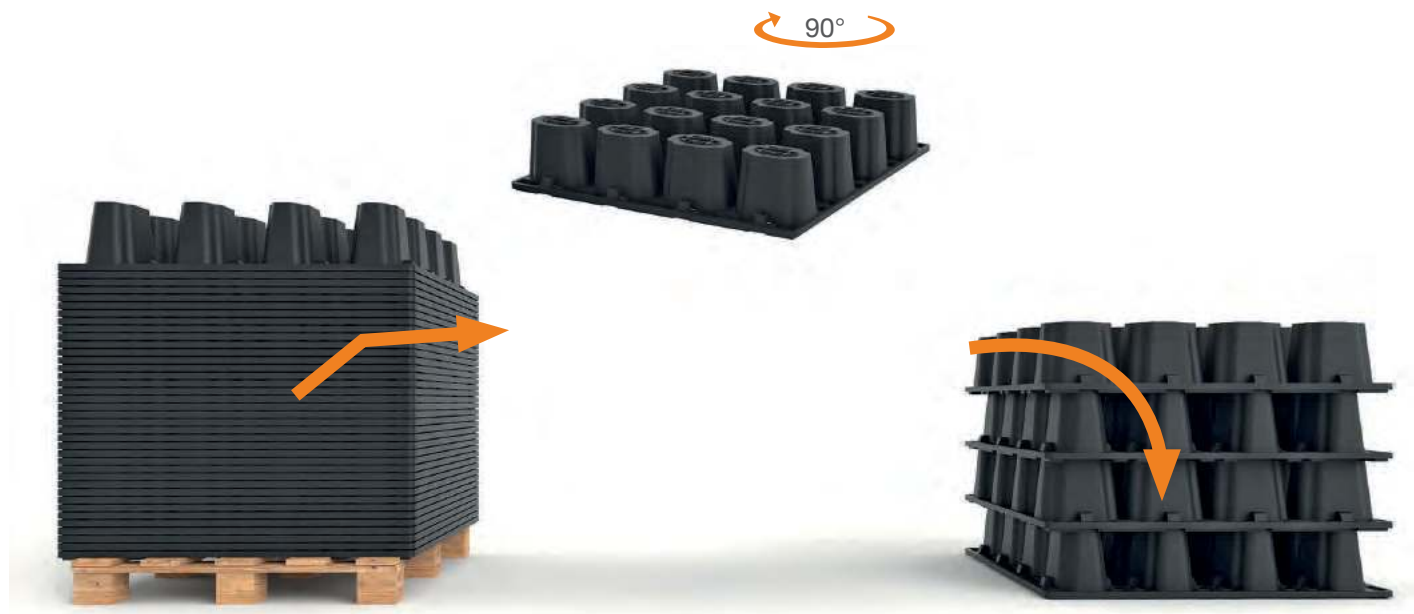

Drainpanel's innovative design allows for easy stacking of the elements (oriented the same way), which minimises the space required for storage and transporting of the material. The installation is carried out by rotating the elements by 90° with respect to those of the underlying layer, thus obtaining a high storage-capacity tank.

## COMPARISON OF TRANSPORT BETWEEN GRAVEL AND DRAINPANEL

One truck is capable of transporting about 25 pallets of Drainpanel for a total of 1875 pieces. Considering that a dumper truck can transport up to 20 m<sup>3</sup> of material at a time, as many as 75 vehicles have to be loaded to achieve a system of equivalent capacity using gravel.

**75 truckloads**  
of gravel 20 m<sup>3</sup> each

**= 450 m<sup>3</sup>**

of water

VS

**1 truckload**  
of Drainpanel

**= 450 m<sup>3</sup>**

of water

# AQUABOX



## GEOCELLULAR STORMWATER MANAGEMENT SYSTEM



# THE SOLUTION

Aquabox is a modular underground retention unit made of virgin or regenerated polypropylene, designed for the sustainable management of rainwater.

Built areas can suffer flooding due to lack of proper rainwater management. Aquabox is used for controlling a rainwater by creating infiltration, storage and retention tanks or collection tanks to reuse water and turn it into a resource.

The elements are assembled on site and joined by high-strength connectors that ensure the stability of the tank.

Thanks to its high mechanical resistance, Aquabox can be installed both in urban areas and in industrial/commercial areas subject to heavy vehicle traffic.

fast and easy installation

high load resistance



## RAINWATER INFILTRATION

## STORMWATER ATTENUATION

## RAINWATER HARVESTING

# THE CONCEPT: HIGH VOID RATIO

Aquabox is an alternative to gravel pits.

The assembled module guarantees a void ratio that is 3 times greater than gravel. Due to its shape, Aquabox stores a high volume of rainwater while significantly reducing the volume of excavation.

Each assembled Aquabox element offers a net water storage capacity of 432 litres (nominal 450 litres). Designers and clients prefer the Aquabox system over traditional methods (gravel and pipes) thanks to its very high void ratio (96%).

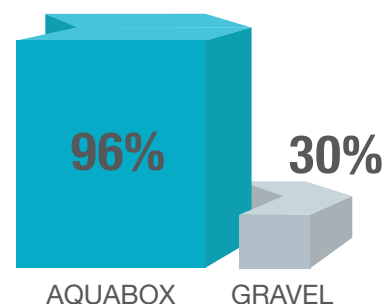

# ADVANTAGES

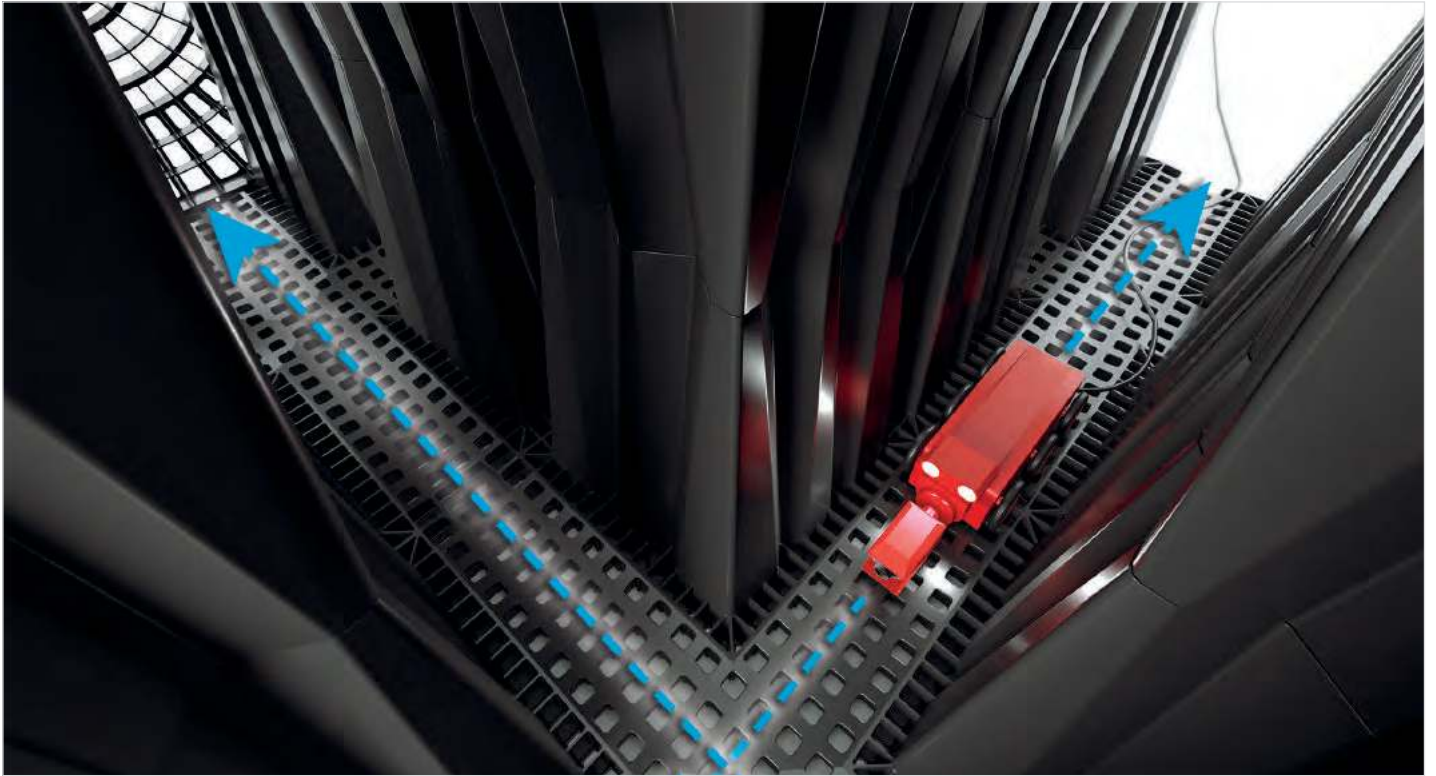

Each Aquabox module is formed by coupling two semi-modules. The system is composed of a series of modules joined by snap-lock clips and confined by lateral grids and upper closing covers: all these elements together create structural voids suitable for underground rainwater management.

## **HIGH STRENGTH**

The load-bearing capacity of a rainwater management system is essential for effective and durable system design.

The system was designed for use up to SLW 60 / HGV 60 and installation depths of up to 6.3 m: its honeycomb structure is solid and rigid, thanks also to the integrated fastening system and high-strength connectors.

## **HIGH VOID RATIO**

The Aquabox system allows storage volumes of rainwater equal to 96% of the nominal volume of the basin, guaranteeing a void ratio that is 3 to 4 times higher than gravel, with consequent savings in the surfaces used and a reduction in excavation depth.

Aquabox will reduce the risk of flooding in impervious urban areas.

## **INSPECTABLE**

The internal configuration of the modules makes the system easily accessible for inspection, routine maintenance and cleaning.

The cavities are designed to allow the entrance of a wheeled camera to make a video inspection of the basin in any direction and on all levels.



# STORMWATER MANAGEMENT



Aquabox was designed to meet the technical, logistical and economic needs of the stakeholders involved in the design, construction and management of underground tanks: the design community, the installation and building companies, and last but not least, the bodies that contract and then manage the water and rainwater drainage networks. Aquabox brings important benefits to each of them.



## MODULAR

Aquabox is a system of 75 x 75 x H80 cm modular elements that is easy to manage at all different stages: from design to installation on site.

The elements are easy to handle and have dimensions and weights optimised for high productivity on site.

Finally, logistics are fully rationalised as the packaging makes full use of the available volumes in the transport vehicles and containers.



## STACKABLE

The Aquabox elements were designed according to the philosophy of maximum possible packing density: all the larger elements are stackable, allowing 460 m<sup>3</sup> of installed volume to be transported in just 60 m<sup>3</sup> of packaging and a single truck load. The economic, logistical and environmental advantages are very clear and appreciated by all the players in the value chain.



## VERSATILE

Each project and each tank has its own history and its unique requirements: Aquabox is designed as an open and flexible system that can be used for different loads and tank depths.

The Aquabox element, produced in 4 different versions, was designed to meet a wide range of different needs: materials with high mechanical performance meet the requirements of strict technical specifications and performance; while the use of 100% regenerated materials meet the sustainability requirements that demanded for environmental preservation.

# THE AQUABOX SYSTEM

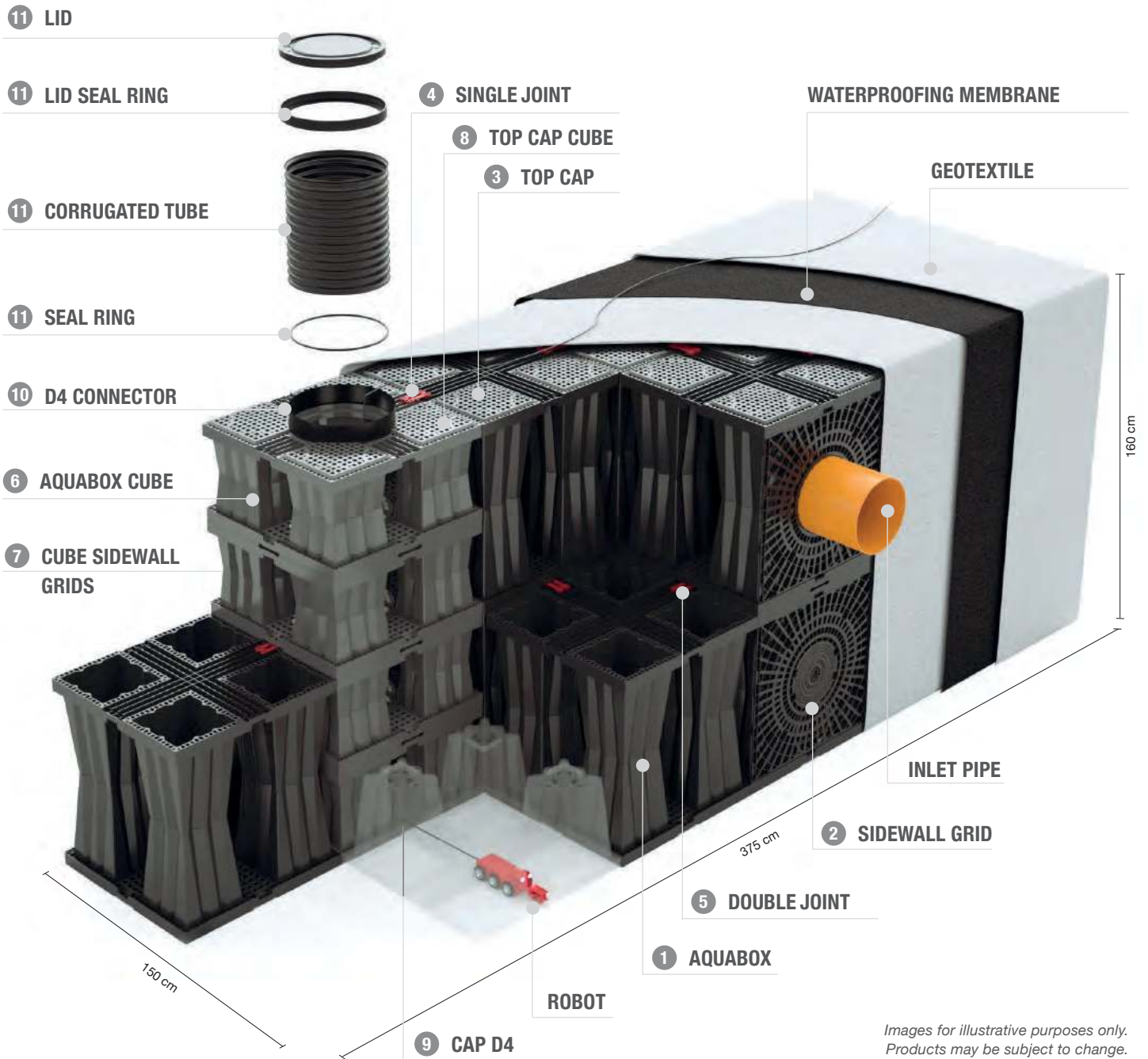

*Images for illustrative purposes only. Products may be subject to change.*

## SYSTEM COMPONENTS

<b>1</b> AQUABOX	<b>2</b> SIDEWALL GRID	<b>3</b> TOP CAP	<b>4</b> SINGLE JOINT	<b>5</b> DOUBLE JOINT	<b>11</b> INSPECTION ACCESSORIES
<b>6</b> AQUABOX CUBE	<b>7</b> CUBE SEDEWALL GRID	<b>8</b> TOP CAP CUBE	<b>9</b> CAP D4	<b>10</b> D4 CONNECTOR	

## CUBE POSITION

The Aquabox Cube shaft can be placed in any point of the tank.

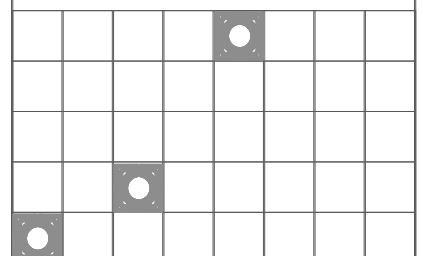

# AQUABOX

Aquabox is a modular element in plastic material used for the realization of underground basins for rainwater infiltration, detention and harvesting.

The Aqualock mounting system makes it possible for each module to be pre-assembled by one person without the use of cranes or mechanical means.

Finally, the modules are installed in-situ very quickly; in the case of multi-level basins the single and double connectors guarantee stability and solidity of the basin.

Each Aquabox module is composed by two assembled semi-modules, its total height is 800 mm.



## SIDEWALL GRIDS

The sides of the tank are closed by the Sidwall Grids, which distribute lateral loads and make installation of geotextiles and waterproofing membranes easy. They also enable the connection of inlet and outlet pipes with pipe diameters up to DN500 mm.



## TOP CAPS

The upper surface of each element is equipped with four perforated closing lids that allow the passage of water. At the same time, these closures create a homogeneous walkable surface which is useful both during installation and to distribute the loads acting on the system.



## SINGLE JOINT

It allows the simple and quick horizontal connection of the Aquabox modules placed in the first and last level.

## AQUABOX SINGLE

Hollow semi-module formed by four truncated-pyramidal pillars (H=400 mm).



## DOUBLE JOINT

Allows quick and easy horizontal connection of the Aquabox modules located in the intermediate levels.

# AQUABOX CUBE - INSPECTION

Aquabox Cube is a modular hollow element in virgin or regenerated polypropylene, designed to make inspection shafts for the inspection and management of Aquabox underground tanks.

The modularity of the elements always allows the installation in all tanks, even multi-layered ones. Four assembled Aquabox Cube elements are 800 mm high, the equivalent of two assembled Aquabox elements.

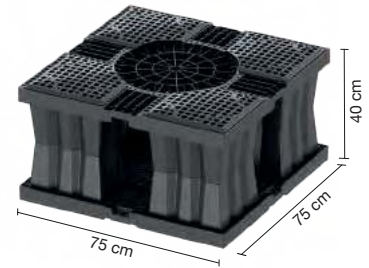

## CUBE SIDEWALL GRIDS

Grids are used on the sides of the tank. This allows a even distribution of side loads and the simple installation of geotextiles or waterproofing membranes. Moreover, being pre-shaped, they allow the connection of pipes of different diameters for the management of incoming and outgoing flow rates.

## CUBE TOP CAP

The upper surface of each element is equipped with four perforated closing caps that allow water to pass through. At the same time, these caps create a homogeneous surface that can be walked on, which is useful both during installation and for the distribution of the loads acting on the system.

## SINGLE JOINT

Allows quick and easy horizontal connection of the Aquabox Cube modules with the Aquabox modules located in the first and last level of the basin.

## AQUABOX CUBE SINGLE

Half module made of 4 internally hollow truncated cone elements. (H= 200 mm)

## DOUBLE JOINT

Allows quick and easy horizontal connection of the Aquabox Cube modules with the Aquabox modules located in the intermediate layers.

## D4 CAP

Circular lid to close the bottom side of the Aquabox Cube inspection shaft.

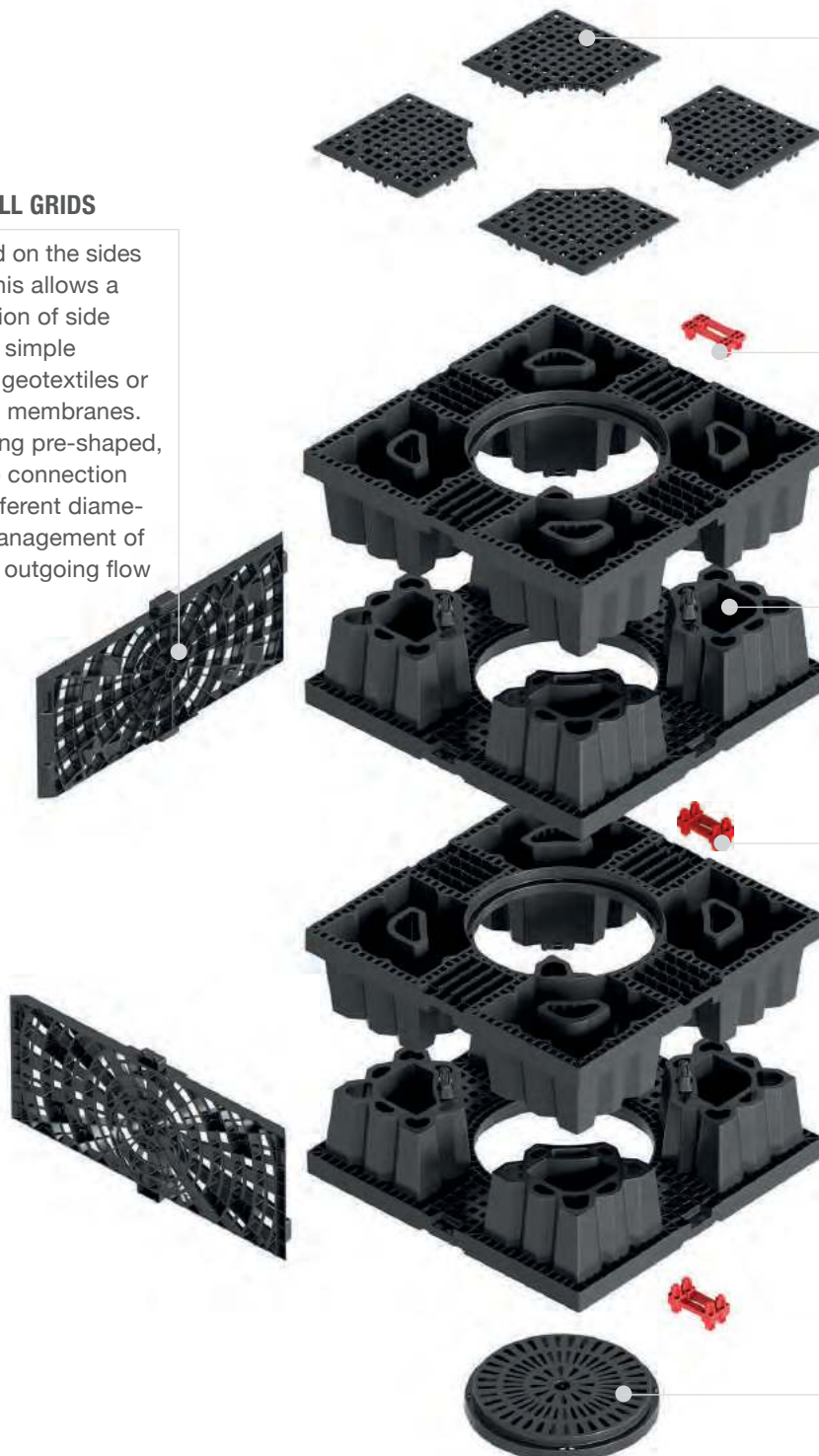

# SYSTEM COMPONENTS







## TOP CAPS AND D4 CAP



The Top Cap is the top closing element for Aquabox and Aquabox Cube, to be installed only on the upper level of the Aquabox installation. The Top Cap is the top closing element in common for Aquabox and Aquabox Cube, to be installed only on the upper level of the Aquabox installation. The D4 Cap is used to close the Aquabox Cube shaft at the bottom of the tank and, if required, to close the upper side as well if Aquabox Cube is not used as access point to the tank.



## INSPECTION SHAFT ACCESSORIES

	<b>LID</b> Ø400 mm	
	<b>LID SEAL RING</b> Ø400 mm	
	<b>CORRUGATED TUBE</b> Ø400 mm	
	<b>SEAL RING</b> Ø400 mm	
	<b>D4 CONNECTOR</b> Ø400 mm	

# AQUABOX SIDEWALL GRID

The Aquabox sidewall grid is used to close the lateral surface of the basin and is fixed to Aquabox with a simple integrated clip.

Each grid is equipped with templates corresponding to the market-standard diameters for inlet/outlet pipes.

The sidewall grids are designed to close the side of the basin and perfectly support the membranes chosen to wrap it.

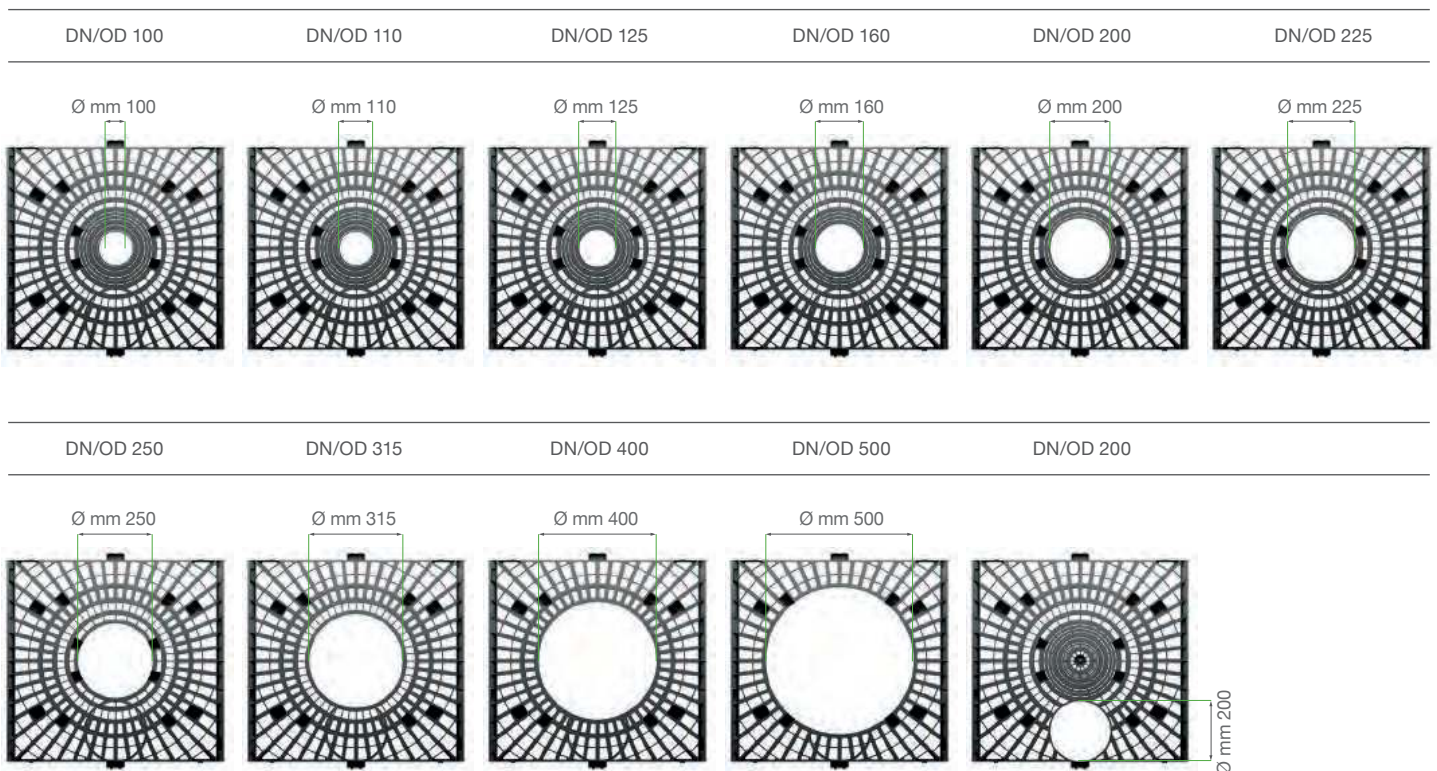
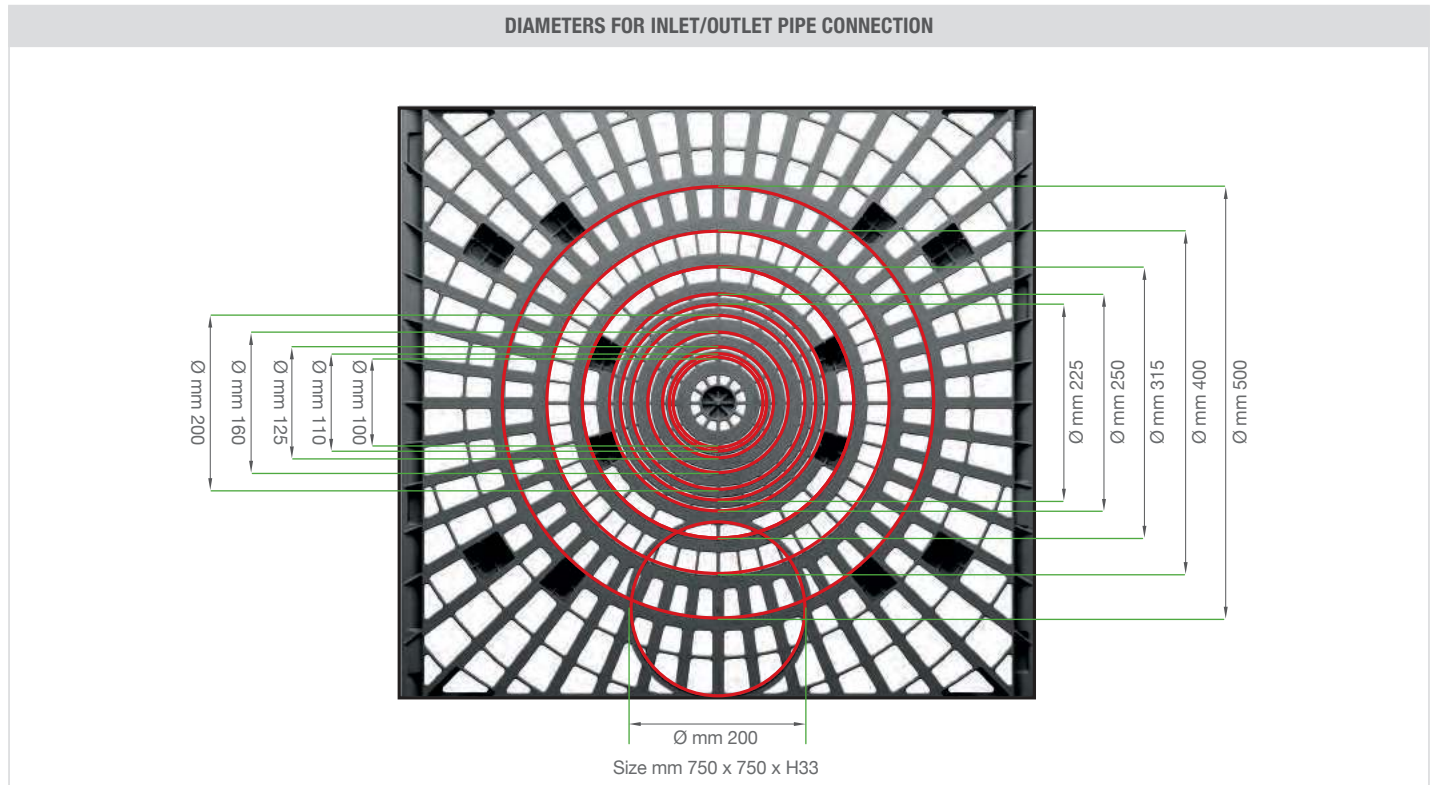

## AQUABOX CUBE SIDEWALL GRID

The Aquabox Cube sidewall grid is used for the side closing of each module when the access point is installed at the perimeter or at the edge of the basin.

If the Aquabox Cube is used inside the basin, no side grid is required.

### DIAMETERS FOR INLET/OUTLET PIPE CONNECTION

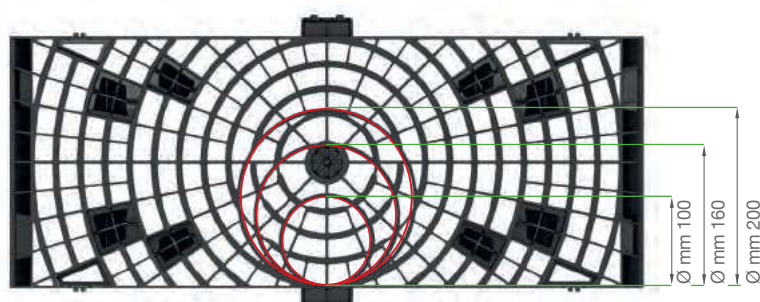

Size mm 296 x 746 x H26

$\varnothing$  mm 100

$\varnothing$  mm 160

$\varnothing$  mm 200

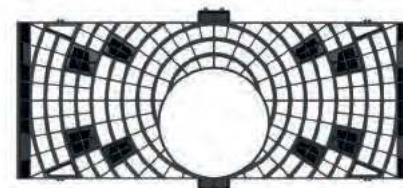
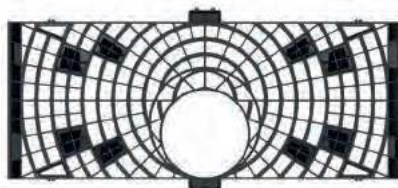
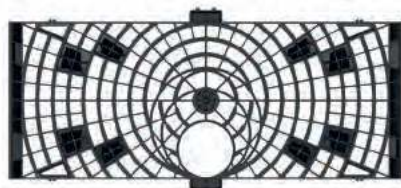

## THE AQUALOCK CONNECTOR

The functional design has led to the development of the Aqualock snap-lock connector, that allows a quick, intuitive and safe assembly.

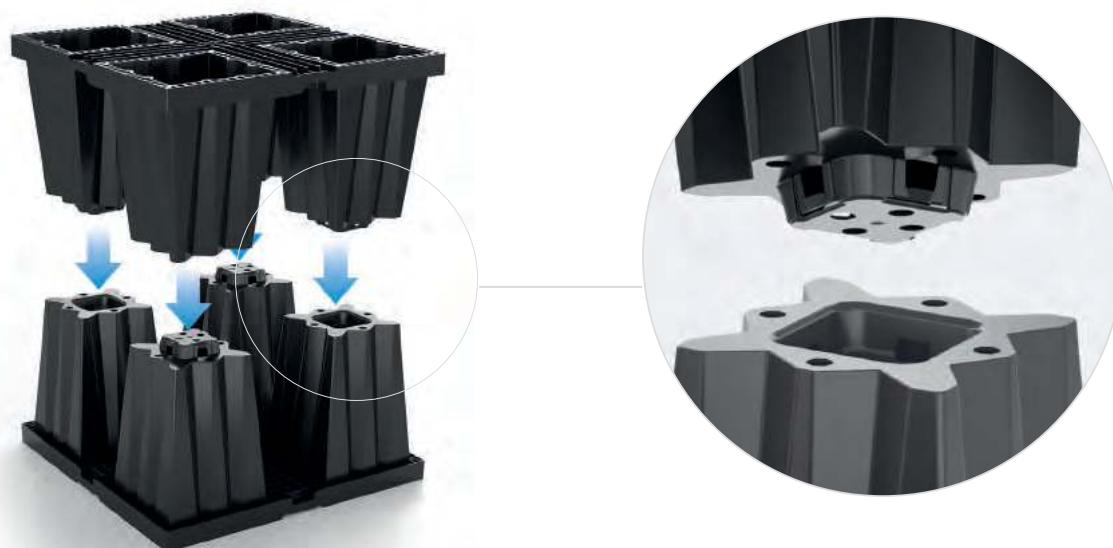

# AQUABOX HP AND HPR FOR HEAVY GOODS VEHICLES

The choice of Aquabox HP and HPR is based on the depth of the excavation, the storage volume required and the applied loads.

Underground drainage basins with Aquabox HP and HPR allow the overlying surfaces to be used for the following purposes:

**SLW 60 / HGV 60 RATED SURFACES**

**ACCESS RAMPS FOR HEAVY GOODS VEHICLES**

**ACCESS ROADS TO INDUSTRIAL AREAS**

**PARKING AREAS FOR SPECIAL VEHICLES  
(TRUCK MIXERS, FIRE ENGINES)**

Aquabox HP responds to the most stringent specifications, with high load conditions and demand for high mechanical performance.

For projects requiring the highest possible system performance, and high installation depth (up to 6.3 m) Geoplast produces Aquabox HPR in Graplene VNFV15 from virgin polypropylene.

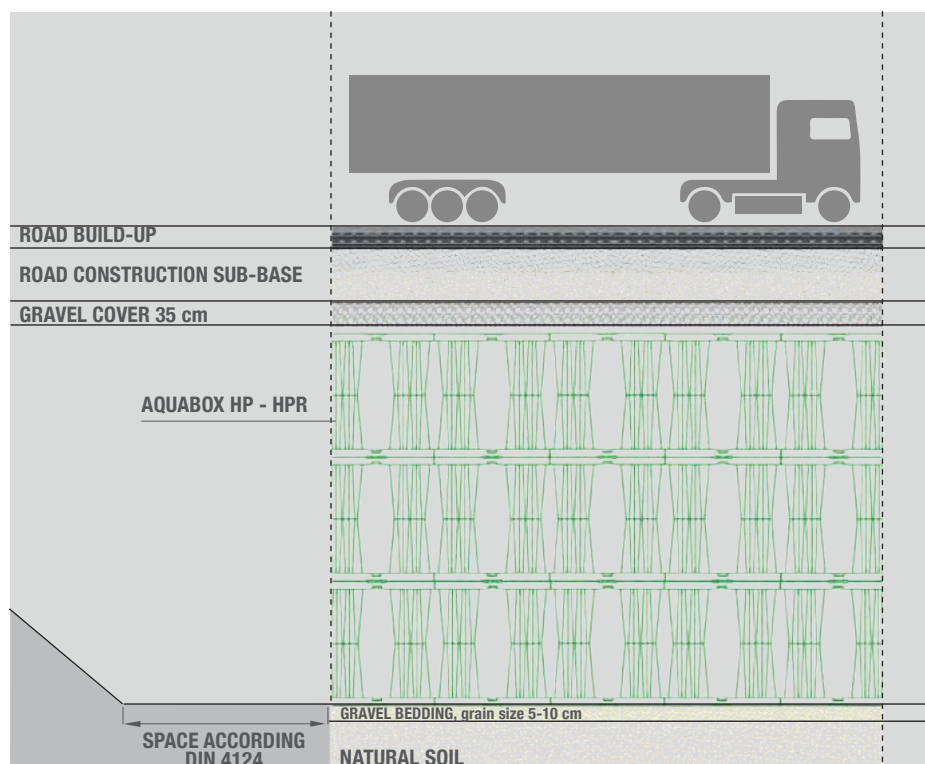

## TANK DEPTH

up to  
**6.3 M** \*

When building a tank under a road surface an upper levelling layer (ballast base layer) with a thickness of at least 350 mm must be applied. A further road construction sub-base according to norm/directive is absolutely necessary.

Aquabox HP and HPR are suitable for traffic loads up to SLW 60 / HGV 60.

An analysis specific to your project can be prepared by Geoplast's technical department which, depending on the project, can assess the maximum depth of installation.

\* The fields of application of the system must be verified and agreed with the Geoplast technical office.  
40





Aquabox HP and HPR are designed for the passage of heavy vehicles, load class SLW 60 / HGV 60. The basin is equipped with access points for inspection and cleaning of the basin.

Aquabox HP and HPR are designed for a useful lifetime of 50 years.



**AQUABOX HPR    AQUABOX HP**

Maximum installation depth (m) tank base	<b>6.3</b>	<b>6.1</b>
---	------------	------------

Loads according to DIN1072. In the case of frost-related requirements, minimum covering 0.8 m according to DIN1054, or following the locally applicable norms and regulations.

For a correct sizing of the tank please contact Geoplast Spa.

# AQUABOX STR

## FOR CARS AND COMMERCIAL VEHICLES

The choice of Aquabox STR is based on the depth of the excavation, the storage volume required and the type of applied loads.

Underground drainage basins with Aquabox STR allow the overlying surfaces to be used for the following purposes:

**SLW 30 / HGV 30 RATED SURFACES**

**ACCESS ROADS TO RESIDENTIAL AREAS**

**PARKING AREAS FOR CARS AND LIGHT VEHICLES**

**CYCLING TRACKS**

Aquabox STR is the most popular choice for regularly loaded traffic situations.

Made from Graplene FV5, a 100% recycled polypropylene. Compatible with water network technology used in public works, it can be inspected and connected to any rainwater pre-treatment and filtering system.

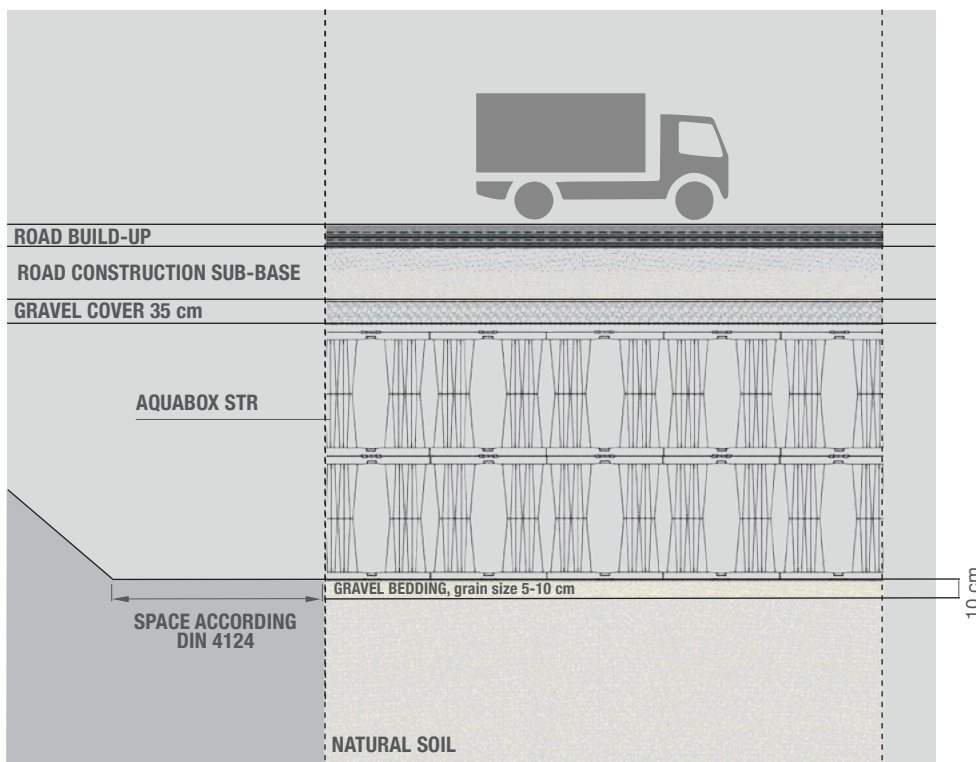
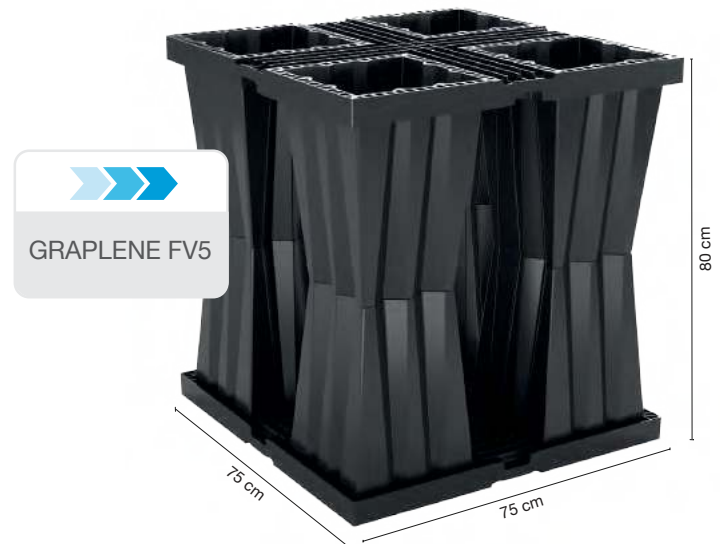

### TANK DEPTH

up to **4.2 M** \*

When building a tank under a road surface an upper levelling layer (ballast base layer) with a thickness of at least 350 mm must be applied.

A further road construction sub-base according to norm/directive is absolutely necessary.

Aquabox STR is suitable for traffic loads up to SLW 30 / HGV 30.

A project of specific stability analysis can be prepared by Geoplast's technical department which, depending on the project, can assess the maximum depth of installation.

\* The fields of application of the system must be verified and agreed with the Geoplast technical office.



Aquabox STR is suitable for the passage of vehicles with load class SLW 30 / HGV 30. The basin is equipped with access points for inspection and cleaning of the basin.

Aquabox STR is designed for a useful lifetime of 50 years.

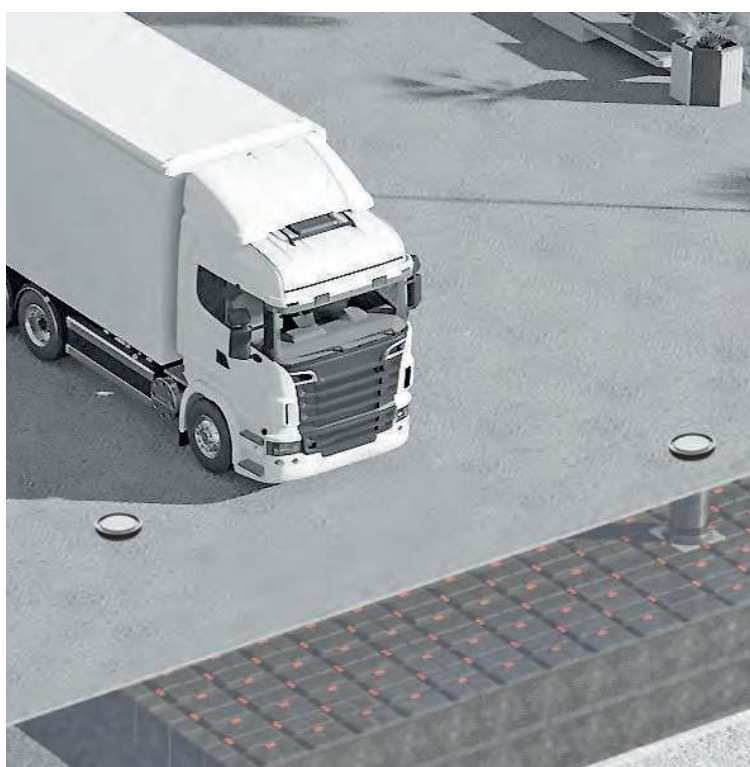

**SLW 30 (60)** ✓  
**HGV 30 (60)**

**AQUABOX STR**

Maximum installation depth (m)  
tank base

**4.2**

Loads according to DIN1072. In the case of frost-related requirements, minimum covering 0.8 m according to DIN1054, or following the locally applicable norms and regulations.

For a correct sizing of the tank please contact Geoplast Spa.

# AQUABOX ST FOR LANDSCAPING LOADS

The choice of Aquabox ST is based on the depth of the excavation, the storage volume required and the type of applied loads.

Underground drainage basins with Aquabox ST allow the overlying surfaces to be used for the following purposes:

**GREEN AREAS**

**LANDSCAPING AREAS**

**WALKWAYS AND PARKS**

**RECREATIONS AREAS AND PLAYGROUNDS**

Aquabox ST is a product made of Graplene, a 100% recycled polypropylene blend.

It is the best choice for cases where extreme technical characteristics are not required, in landscaped areas without vehicular traffic.

Aquabox ST has the same excellent access and inspection characteristics as the rest of the range: for this reason, and thanks to its high useful volume, the system is suitable for reuse storage for irrigation of parks and gardens.

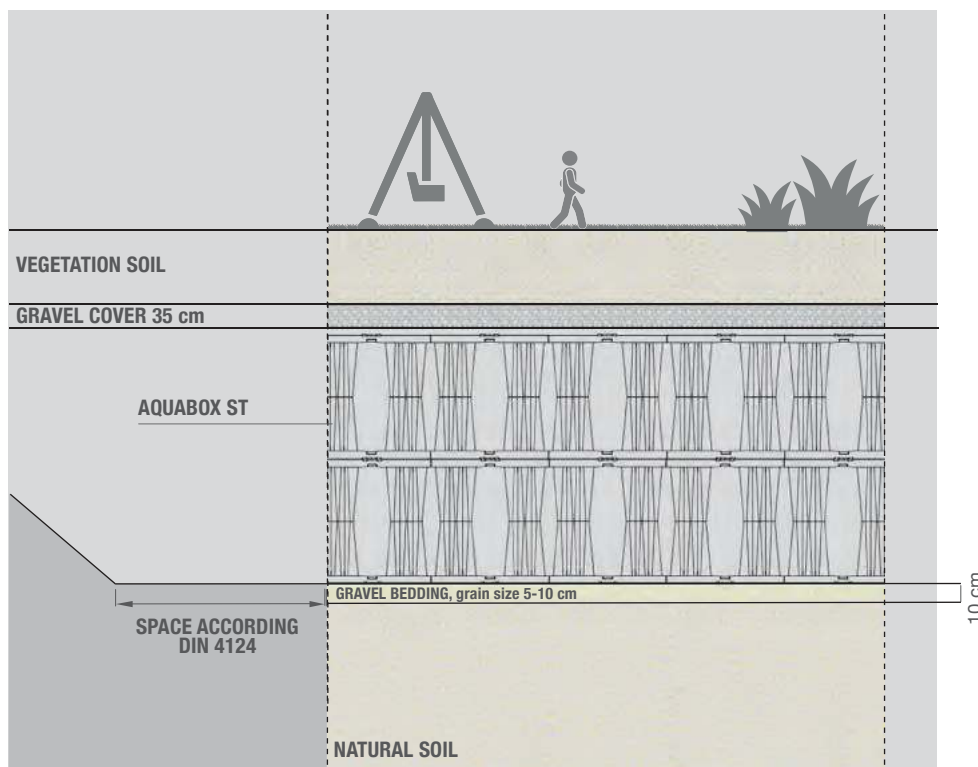
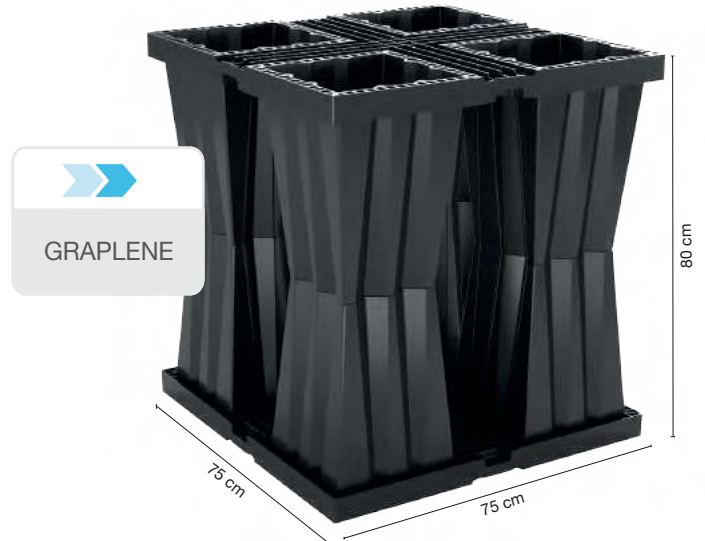

## TANK DEPTH

up to **3.1 M** \*

The minimum cover of Aquabox ST underground basins is mainly related to the type of flooring or the vegetation expected on site. In the case of vegetation, care should be taken to ensure sufficient soil depth for the chosen plant species. It is also advisable to avoid tall trees or shrubs with deep roots to avoid intrusion into the basin.

A project of specific stability analysis can be prepared by Geoplast's technical department which, depending on the project, can assess the maximum depth of installation.

\* The fields of application of the system must be verified and agreed with the Geoplast technical office.



Aquabox ST is designed for landscaping loads and areas without access to vehicle traffic. The tank is equipped with access points for inspection and cleaning of the basin.

Aquabox ST is designed for a useful lifetime of 50 years.

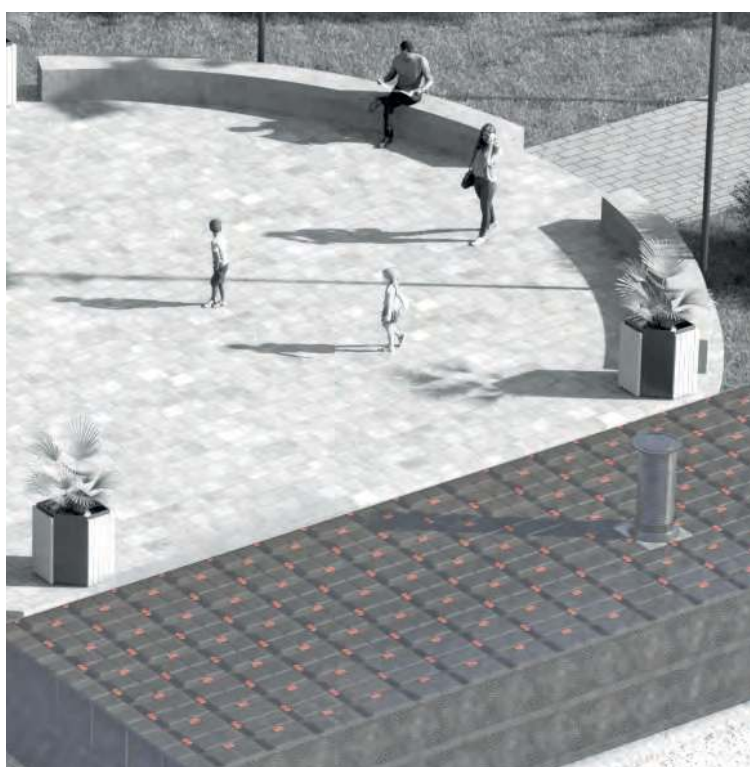

#### AQUABOX ST

Maximum installation depth (m)  
tank base

3.1

Loads according to DIN1072. In the case of frost-related requirements, minimum covering 0.8 m according to DIN1054, or following the locally applicable norms and regulations.

For a correct sizing of the tank please contact Geoplast Spa.

# INFILTRATION

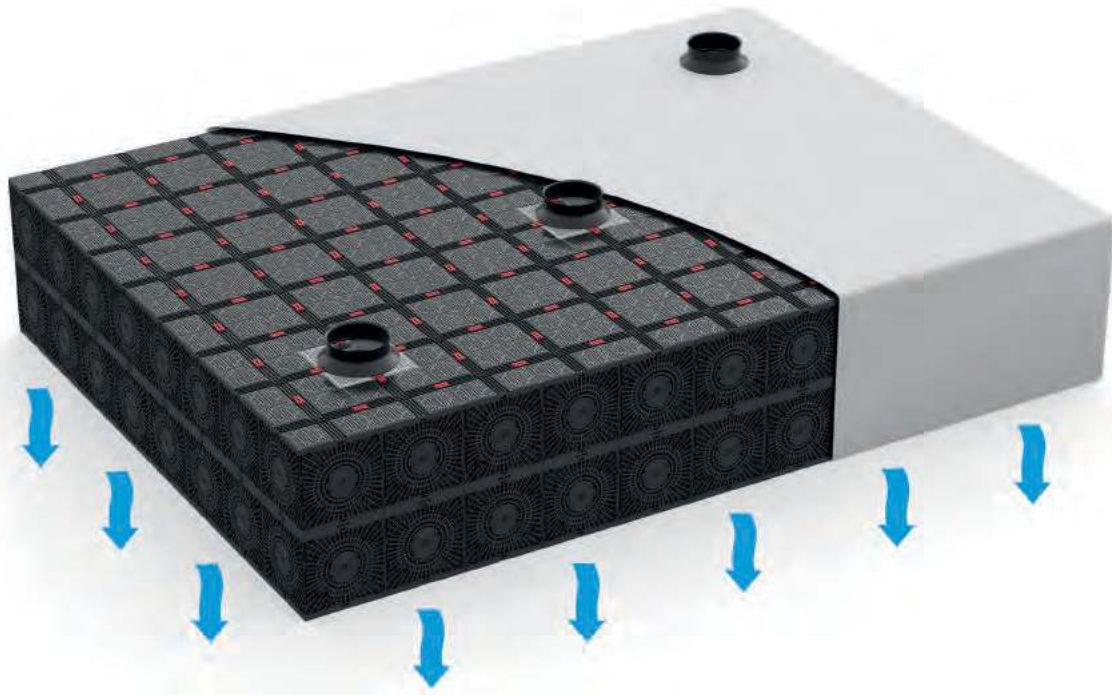

The replenishment of groundwater aquifers during heavy rainfalls is a crucial design point in stormwater management regulations. An Aquabox basin is a good solution for rainwater infiltration, promoting its management in situ and contributing to the restoration of the natural water cycle. The system stores incoming water and releases it gradually into the ground. The soil must have geotechnical characteristics of permeability such that it is able to receive the water stored in the Aquabox basin.

**Advantage:** compared to traditional methods (gravel or pipes) the useful storage volume for equal volume is 3 times higher. This results in a lower cost for digging, excavation work and disposing of the dig material (sand, gravel, stones).

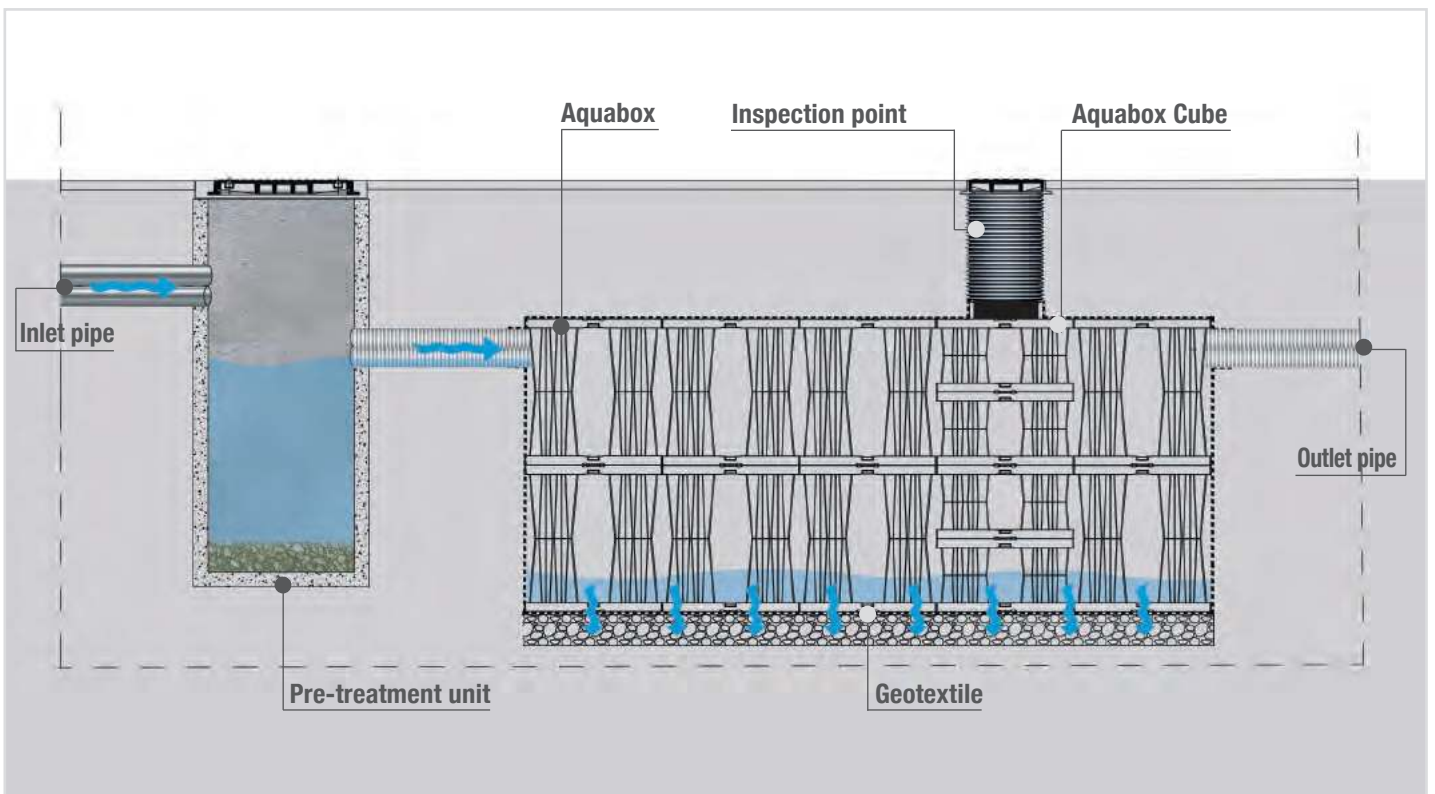

# ATTENUATION



Where the permeability of the soil is poor and water cannot penetrate into the soil, storage tanks must be built. The attenuation tank allows to attenuate the peak flow rates avoiding the overloading of the sewer and the receiving water bodies.

After filling, the release takes place through a special drain pipe placed in the lowest layer of the basin and designed for gradual outflow rate, not exceeding the maximum discharge rate allowed by the planning authorities.

**Advantage:** less stress on the water infrastructure. It reduces the flood flow rates that depend on the capacity of the downstream drainage system to convey water.

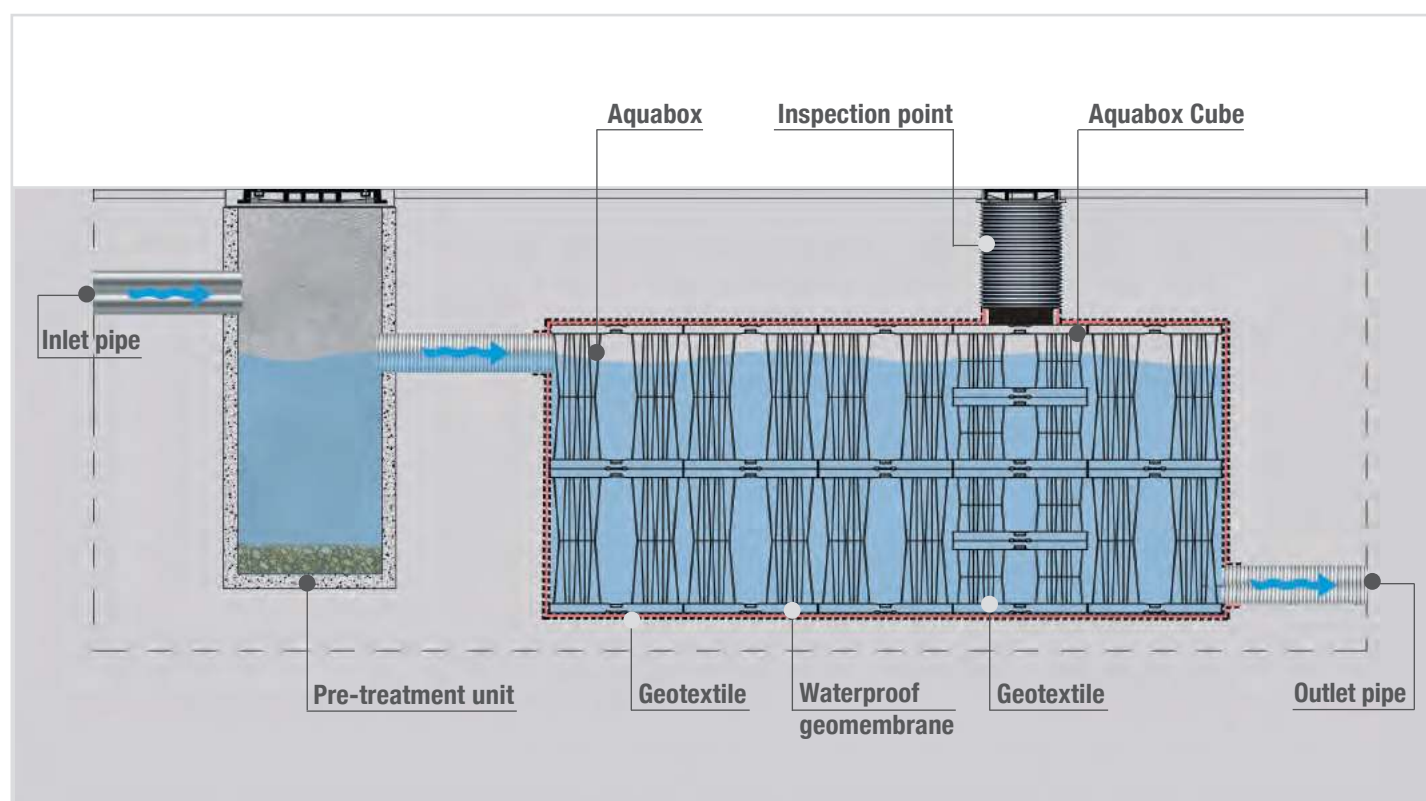

# HARVESTING FOR REUSE



The rainwater running off from roofs or other surfaces and harvested for reuse is always channeled through a suitable pre-treatment stage before it can enter the storage tank. The water is conveyed into the Aquabox basin through one or more inlet pipes and is extracted when necessary with a pump housed in a suitably placed Aquabox Cube shaft.

**Advantage:** lower water supply costs and lower municipal wastewater charges.

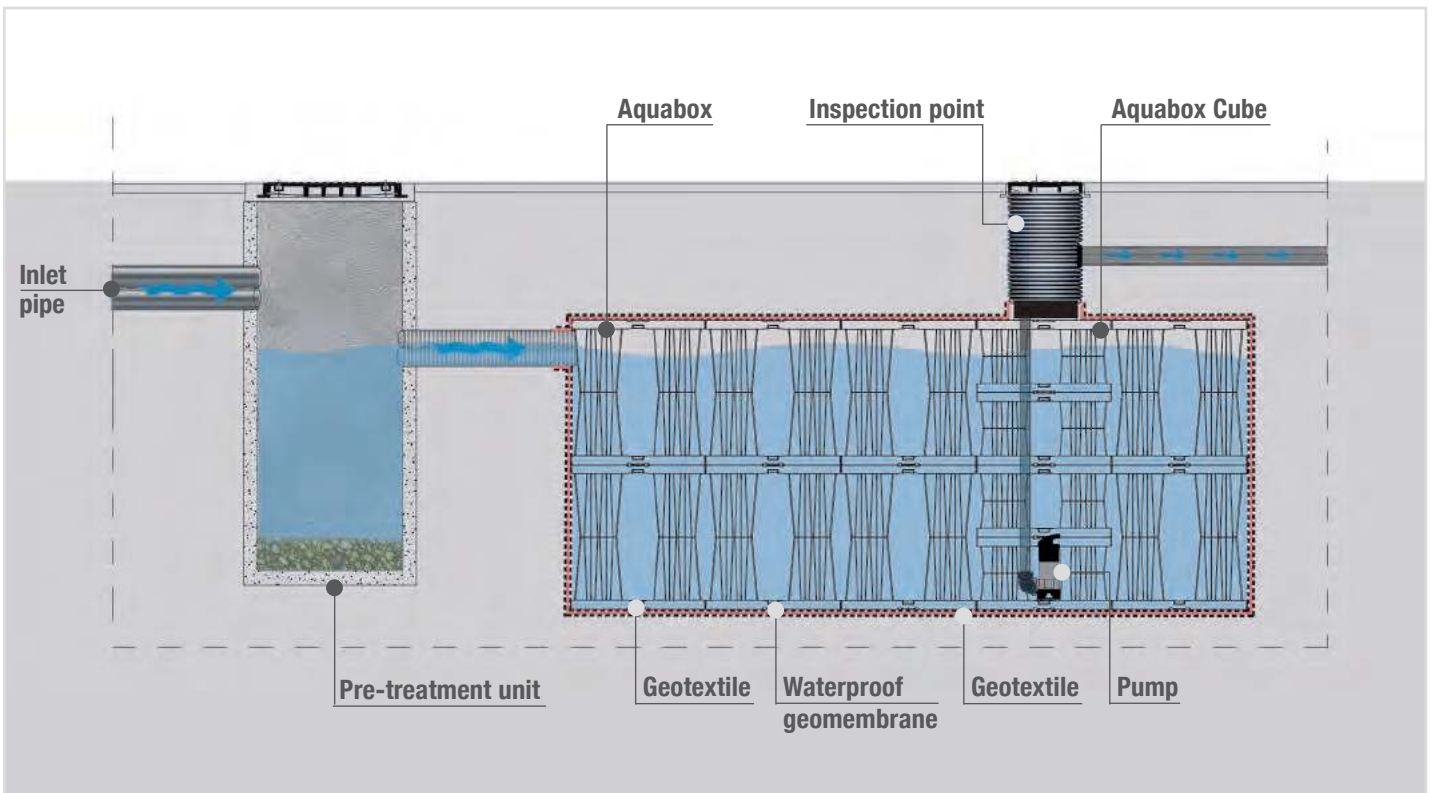



# 360° INSPECTION AND CLEANING



## INSPECTION WITH SWIVEL CAMERA



Both during testing and once in operation, the basin must be inspected by a specially designed camera.

Accessibility is always guaranteed by the Aquabox Cube maintenance shafts that allow access to the basin in depth.

The structure of Aquabox offers great visibility and accessibility in every axis of the basin. The operator on the surface receives a live video stream on the whole inspection operation of the basin and the tubes, which can be recorded for offline viewing.

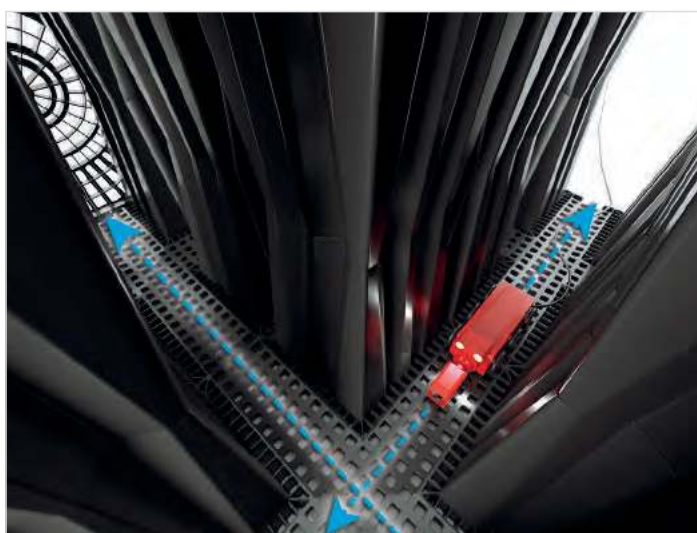

## 360° INSPECTION ON ALL LEVELS AND IN ALL DIRECTIONS



Inspection with a special wheeled camera gives the opportunity to verify the true internal situation of the basin, evaluating its state of repair and the presence of silt deposits.

The concave surfaces of the Aquabox tunnels guarantee the easy passage of an inspection robot.



## HIGH PRESSURE WASHER OF INTERNAL CHANNELS



The internal structure should be cleaned by means of a high-pressure jet cleaner, accessing the basin through the Aquabox Cube shafts located downstream.

Depending on need and situation, the jets be directed forwards or backwards.

With more than 300 meters of hose length the nozzle of the pressure washer will reach every point of the basin and perform a complete cleaning.

# STORAGE AND ASSEMBLY

The innovative design of Aquabox makes stacking the elements very easy, reducing the space used for storage and transport of materials on site.

## Stackable

The modules are stackable and are supplied on pallets of 80 pieces, which are equivalent to 18 m<sup>3</sup> each. The dimensions of the packaging are 80 x 152 x H258 cm.

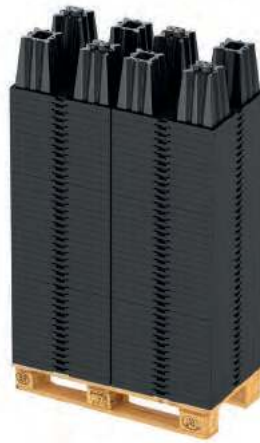

## Easy to install

The “Aqualock” locking system joins two semi-modules, which are assembled before the installation in the basin.



## Ready for use

Once assembled, the Aquabox modules are ready to be laid in the excavation to create the basin. The side walls also serve as connections for the inlet or outlet pipe.

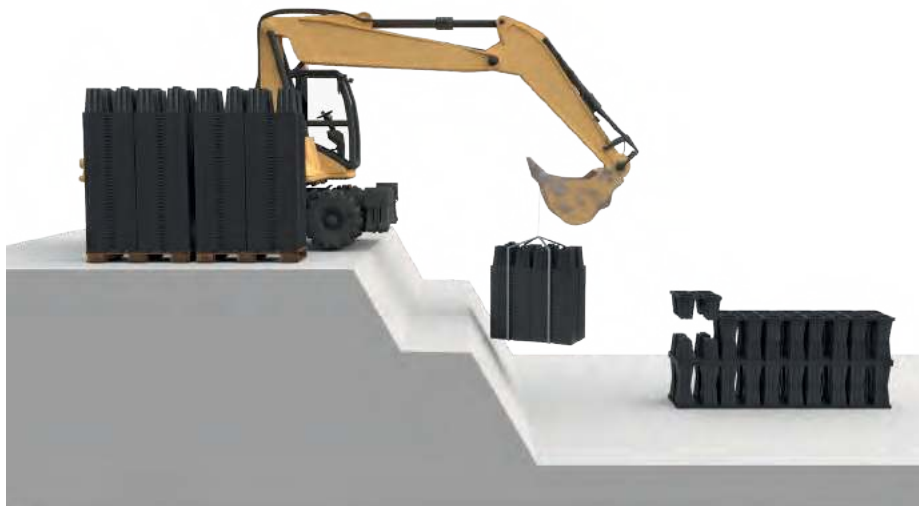

# 88%

**REDUCTION OF STORAGE SURFACE**

compared to non-stackable infiltration/attenuation crates

# LOGISTICS

A classic articulated lorry measuring 13,6 x 2,45 x H2,5 m allows to transport 27 pallets measuring 80 x 152 cm.

Thanks to its shape and stackability, the total volume of product transported per articulated truck is 460 m<sup>3</sup>. This reduces CO<sub>2</sub> emissions considerably when compared to the number of vehicles needed to transport the equivalent storage volume in gravel.



## COMPARISON BETWEEN GRAVEL AND AQUABOX

To build a basin of about 450 m<sup>3</sup> it is possible to use the Aquabox system moving only 1 articulated truck compared to the traditional gravel solution, which requires 75 truckloads.

The advantages are obvious and countless:

**LOGISTICS:** 1 vs. 75 trucks.

**ECONOMIC:** fuel saving, less wear and tear on vehicles, reduction in man-hours and use of earthmoving machinery.

**ENVIRONMENTAL:** lower CO<sub>2</sub> emissions, less disfigurement of the landscape.

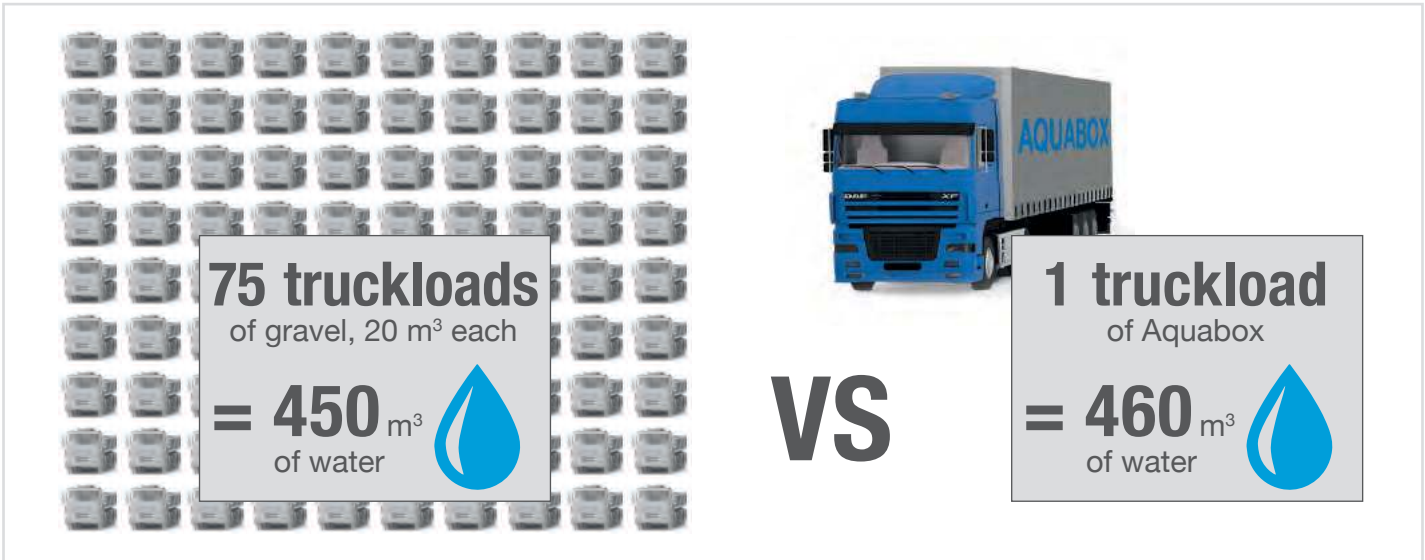

# INSTALLATION



- ① EXCAVATION**  
Hole excavation and verification of the soil permeability by a geologist.



- ② GEOTEXTILE LAYING**  
Place a gravel subbase (size 2-8 mm) and lay a geotextile 200 g/m<sup>2</sup>.



- ③ INSTALL MODULES**  
Install Aquabox assemblies and red connectors as designed.



- ④ INSTALL SIDE GRIDS**  
Install the Side Grids along the sides of the basin.



- ⑤ INSTALL TOP CAPS**  
Install the top caps on the upper side of the basin.



- ⑥ WRAP WITH GEOTEXTILE**  
Close all the remaining surfaces of the tank by wrapping them with a geotextile.



- ⑦ INSPECTION POINT**  
Cut the geotextile above the Aquabox Cube elements in order to create access points to the basin.



- ⑧ BACKFILL AND COVER**  
Backfill 350 mm above the tank. Further backfill is to be carried out according to applicable norm guideline. Total cover depends from the load class.

# LOAD CLASSES

Depending on the loads applied, the area where they will be created and the height of the water table, tanks of different depth can be designed.



AQUABOX	HPR	HP	STR	ST
Max. load class	SLW 60	SLW 60	SLW 30 (SLW 60)	LANDSCAPING
Minimum depth of cover (m)	0,7	0,7	0,5 (0,8)	0,5

Calculation parameters: loads as per DIN1072, specific soil weight 18 kN/m<sup>3</sup>, maximum average soil temperature 20°C, k=0.3. Data valid for infiltration tanks.

In the case of frost-related requirements, minimum covering 0.8 m according to DIN1054, or following the locally applicable norms and regulations.

AQUABOX	HPR	HP	STR	ST
Maximum installation depth (m) at the base of the tank (pedestrian load)	6,3	6,1	4,2	3,1

Valid for 3-layer Aquabox basins. For other conditions, and for a correct sizing of the tank please contact Geoplast Spa. Aquabox has been designed for attenuation tanks wrapped in a waterproof membrane installed at a depth above the maximum level of the water table. In the case of installation below that level a review of the necessary technical conditions is mandatory.

# ELEVATOR TANK



**PERMANENT FORMWORK  
FOR REINFORCED CONCRETE  
WATER STORAGE TANKS**



# THE SOLUTION

Elevetor Tank is a permanent formwork in regenerated polypropylene that creates rainwater storage tanks cast on-site, of variable height and size according to the design requirements.

The reinforced concrete structure created with Elevetor Tank not only has a high resistance to loads, which allows it to be located under surfaces subject to heavy traffic, but also allows a considerable storage volume.

Moreover, the innovative grid at the base allows a simple and quick installation of the PVC pipes that support the system, keeping it perfectly vertical during the placing of concrete.

## STORMWATER ATTENUATION TANKS

## INFRASTRUCTURES AND IRRIGATION

## FIRE-FIGHTING TANKS

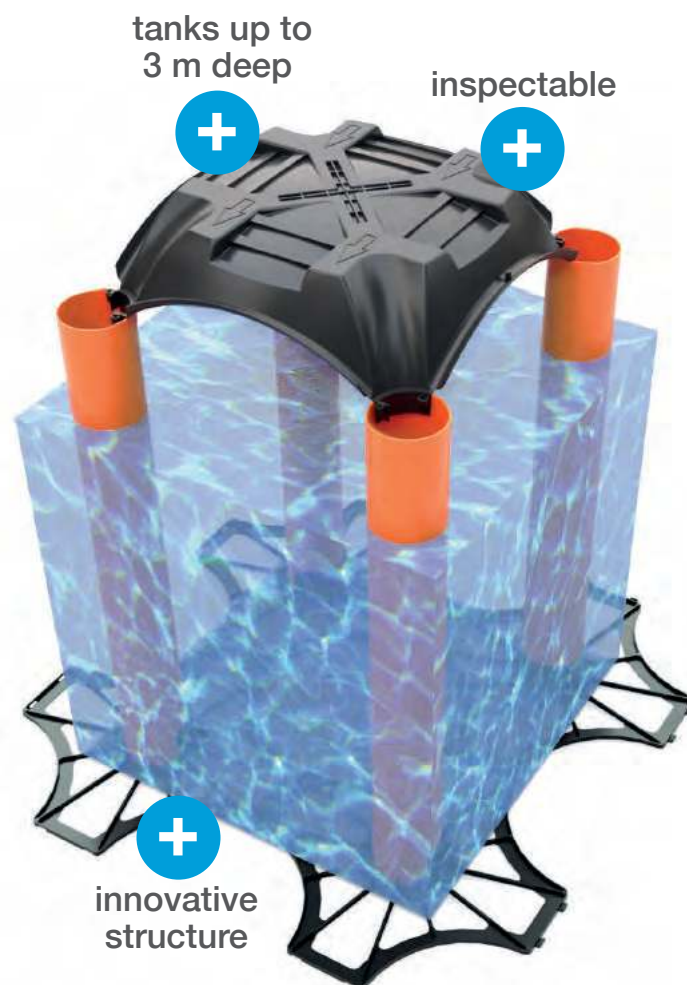

### INSPECTABLE

Elevetor Tank offers an extraordinary flexibility of shape, both in plan and height.

The 58 cm spacing between the columns allows easy access to both remote inspection equipment and visual inspection in situ. It is also possible to create access points through the floor and corridors for easier passage of maintenance personnel.

Height 1 M

Height 1,8 M

Height 3 M

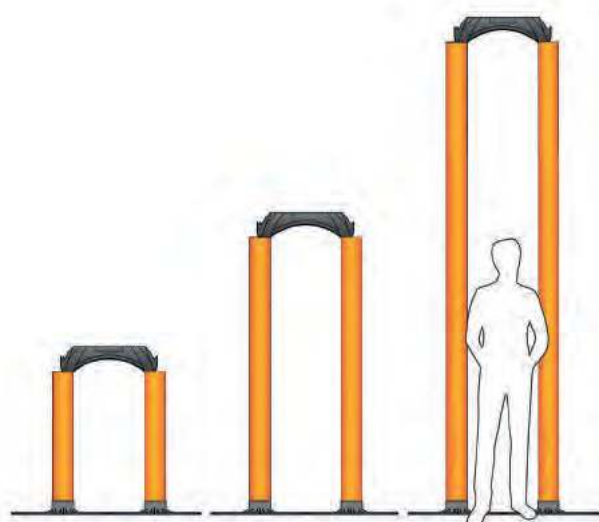

# ADVANTAGES



Elevator Tank is a system designed to carry out a dual task: to preserve the urban environment from floods and at the same time store the rainwater produced even by the most severe event.

The tanks made of concrete (compressive strength class C45/55), is strengthened by a high number of in-situ cast concrete posts which support a thin reinforced concrete slab.

They are used for the construction of fire-fighting water reserves, the irrigation of green areas and more generally to manage peak volumes of rainwater. The concrete slab is load-bearing even under heavy loads and can be inspected to inspect the tank.



## FAST INSTALLATION

Installation operations are simple thanks to the design of the Cuatro and Trio grids, which were designed and patented to guarantee the perpendicularity of the pipes and precision in the hooking of the grids.

The Max version has the wider span of 710 mm features a lower number of pieces per square meter, reducing the installation time.



## STABLE AND SAFE

The formwork safely supports workers during installation and concrete pouring.

The Max version has the wider span of 710 mm features a lower number of pieces per square meter, reducing the installation time.



## LOAD BEARING

The resulting reinforced concrete structure provides high resistance to both permanent and live loads. The system is designed for heavy vehicle traffic with load class up to SLW 60 / HGV 60.



# THE CONCEPT



The Elevator Tank system allows the surface above to be used as a landscaped or paved area with vehicular access.

**THE FOLLOWING PARAMETERS MAY VARY DEPENDING ON THE EXPECTED DESIGN LOADS:**

- ① **MAXIMUM SYSTEM HEIGHT**
- ② **REINFORCEMENT AND THICKNESS OF THE CONCRETE SLAB**
- ③ **REINFORCEMENT OF THE POSTS**

# STRATIGRAPHY

**LEGEND**

- |                            |                      |
|----------------------------|----------------------|
| Ⓐ Road surface             | Ⓕ Retaining walls    |
| Ⓑ Reinforced concrete slab | Ⓖ PVC Pipe           |
| Ⓒ Elevator Tank Form       | Ⓗ Elevator Tank Grid |
| Ⓓ Column's rebar           | Ⓘ Ground slab        |
| Ⓔ Polystyrene strip        | Ⓛ Crushed stone base |

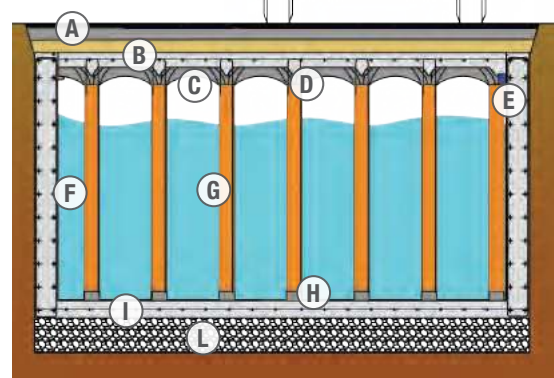

# SYSTEM COMPONENTS

## THE FORMWORK

The formworks are shaped as flattened domes, and are made of regenerated PP. Their size is 580 x 580 mm, and 710 x 710 mm in the Max version. For both formworks the height is 150 mm. Each form is equipped with connectors on each corner for a perfect coupling with the pipes.

The dome shape allows the construction of a reinforced concrete structure with a shape that distributes the loads evenly over the 4 posts, thus making it possible to considerably reduce the thickness of the upper slab compared to classical construction techniques.



## FORMWORK CONNECTORS

The individual forms are linked together, forming at each intersection a collar that in turn fits into the top of the tube.

The combination of the interconnected forms creates a solid formwork surface, ready to accommodate the reinforcement of the slab and fresh concrete.

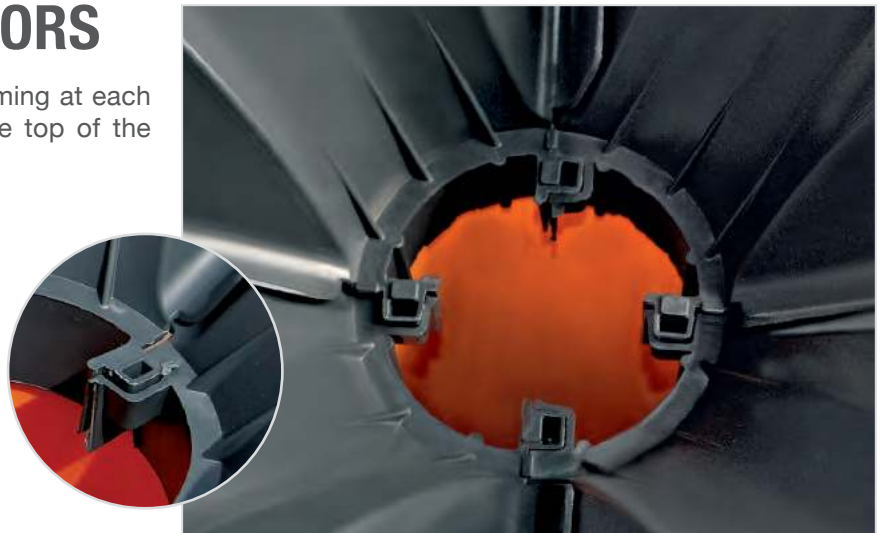

## THE PIPE

The post form is a simple PVC pipe with an external diameter of 125 mm and thickness of 1.8 mm. Inserted in the patented base grid, the pipes support the slab formwork and receive the fresh concrete: their perfect verticality is ensured by the base grid, which plays a fundamental role in 2 aspects:

**SAFETY:** the perfectly aligned and vertical system guarantees safety of the personnel during formwork installation, reinforcement laying and concrete placing.

**STABILITY:** by keeping the pipes perfectly plumb, it allows to obtain a final concrete structure free from distorting effects, which can undermine their stability.

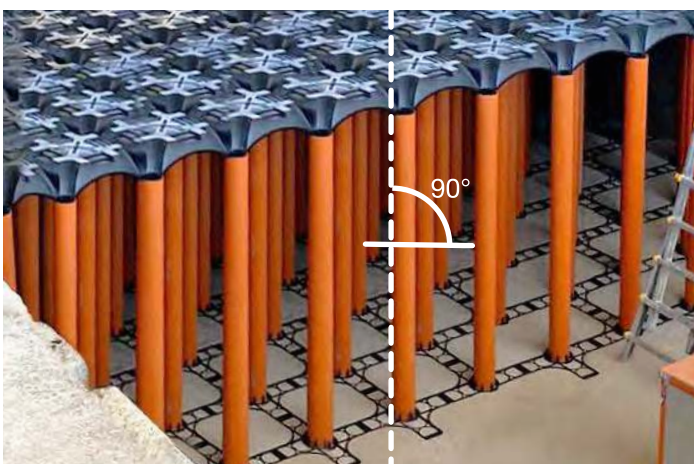

Elevator Tank system with Trio grid

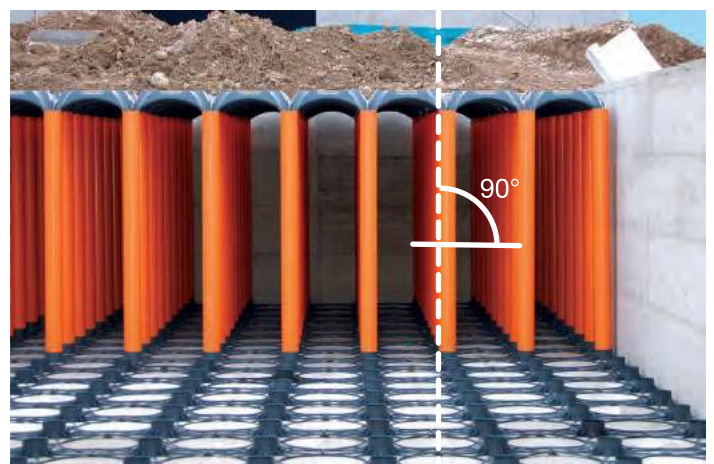

Elevator Tank system with Cuatro grid

## TRIO BASE GRID



### TRIO GRID



## CUATRO BASE GRID



### CUATRO GRID



## MAX BASE GRID



### BASE MAX



## FAST AND PRECISE INSTALLATION

The connection between the basic grids aligns the formwork system in plan (PVC pipes + formworks) and guarantees extreme precision during the assembly phase. The grid is very light, easy to cut and to lay even close to walls.

The use of the base grid is a fundamental advantage of the Elevator Tank system.

It is an extremely light and space-saving element that can be placed very quickly thanks to the special male-female coupling.



## NET STORAGE VOLUME (m<sup>3</sup>/m<sup>2</sup>)

Internal height (cm)	Span 58 x 58 cm		Span 71 x 71 cm	
	ø125 cm	ø125 cm	ø160 cm	ø200 cm
H80	0,626	0,634	0,624	0,609
H90	0,722	0,732	0,720	0,703
H100	0,819	0,829	0,816	0,797
H110	0,915	0,927	0,912	0,890
H120	1,011	1,024	1,008	0,984
H130	1,108	1,122	1,104	1,078
H140	1,204	1,219	1,200	1,171
H150	1,300	1,317	1,296	1,265
H160	1,397	1,414	1,392	1,359
H170	1,493	1,512	1,488	1,453
H180	1,589	1,610	1,584	1,546
H190	1,686	1,707	1,680	1,640
H200	1,782	1,805	1,776	1,734
H210	1,878	1,902	1,872	1,827
H220	1,975	2,000	1,968	1,921
H230	2,071	2,097	2,064	2,015
H240	2,167	2,195	2,160	2,109
H250	2,63	2,292	2,256	2,202
H260			2,351	2,296
H270			2,447	2,390
H280			2,543	2,483
H290			2,639	2,577
H300			2,735	2,671

The net tank height is calculated from the bottom of the tank to the top of the pipe, thus excluding the formwork (15 cm).

<b>CONCRETE CONSUMPTION FLUSH TO THE FORMWORK (m<sup>3</sup>/m<sup>2</sup>)</b> $[A \times (\text{height of the Elevator Tank system (m)} - 0,15)] + C \text{ m}^3/\text{m}^2$				<b>Example:</b> <b>Concrete consumption of a formwork 100 cm high, 58 x 58 cm span</b>  <b>Concrete consumption =</b> $[0,037 \times (1 - 0,15)] + 0,030 = 0,061 \text{ m}^3/\text{m}^2$
Span	Ø Tube mm	A	C m <sup>3</sup> /m <sup>2</sup>	
58 x 58	125	0,035	0,030	
71 x 71	125	0,023	0,036	
71 x 71	160	0,038	0,036	
71 x 71	200	0,059	0,036	

# APPLICABLE LOADS

The maximum permissible height of the Elevator Tank system will vary depending on the applied loads.



For a correct sizing of the structure please contact Geoplast Spa.

## OPTIONAL REINFORCEMENT

For more delicate situations, where the combination of loads and high post height is particularly demanding, it is recommended to insert steel elements (steel bars/ steel forks) inside the pipes in order to ensure the stability of the concrete post even under dynamic loads.

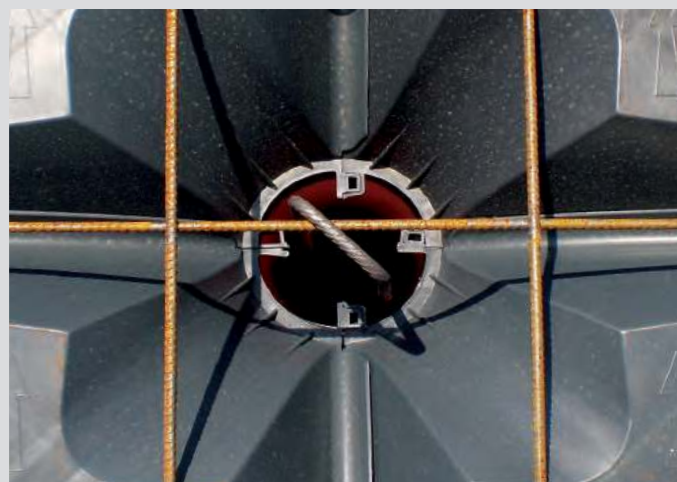

# CONSTRUCTION DETAILS

## TYPICAL ATTENUATION TANK

- (A)** Elevator Tank
- (B)** Rainwater inflow
- (C)** Sedimentation tank
- (D)** Overspill skimmer
- (E)** Pumping station
- (F)** Discharge to final receptor
- (G)** Overflow

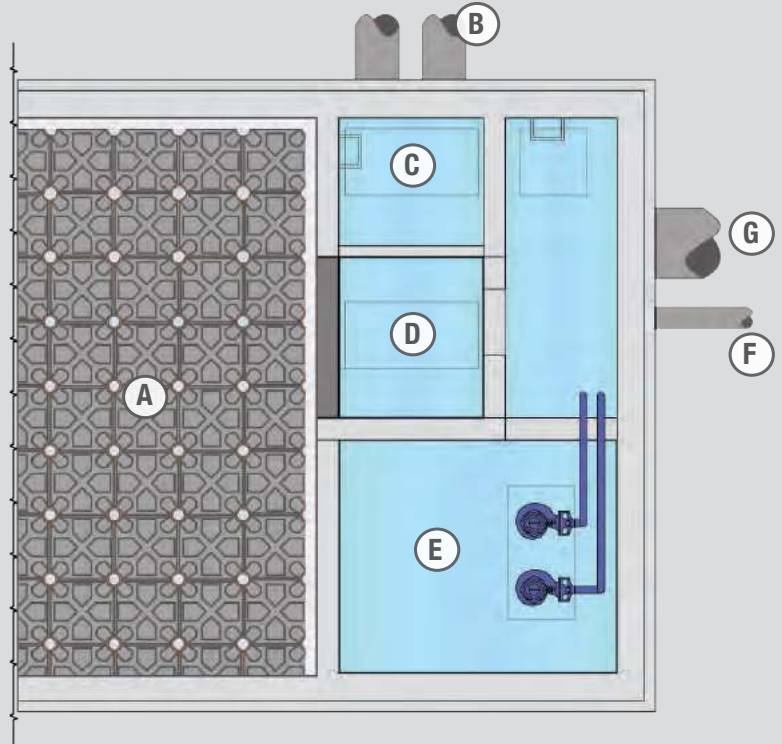

## PUMPING STATION DETAIL

- (A)** Elevator Tank
- (B)** Submersible pump
- (C)** Inspection point

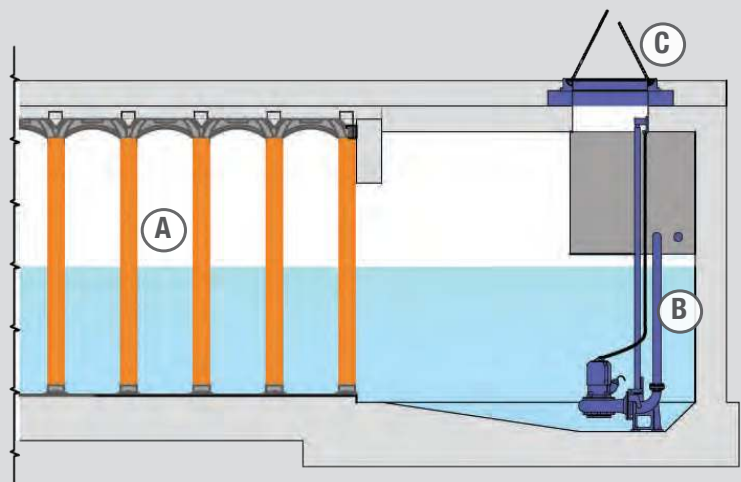

# INSTALLATION



## ① STRUCTURE

Construction of the base and walls of the tank. Preparation of the chambers for pumping equipment, inspection manholes or other hydraulic items.



## ② GRID

Laying of the base grid, critical for the plumb of the pipes and the stability of the system.



## ③ PIPES

Placing of PVC pipes, lodged in the appropriate positions in the base grid.



## ④ DOMES INSTALLATION

The domes are placed from right to left, well connected to the pipes to ensure safety during subsequent operations.



## ⑤ COMPENSATION

On the starting sides, where the forms rest on the retaining wall, the polystyrene infill strips ensure that no concrete is lost.



## ⑥ STEEL REINFORCEMENT

Laying of the welded mesh according to design specifications. Insertion of reinforcement steel rods into the pipes, connected to the welded mesh.



## ⑦ CONCRETE PLACING

Concrete is placed proceeding gradually from one side to the other, vibrating the concrete slab suitably.



## ⑧ FINISHING

Covering of the tank and construction of the specified surface.

# TRIO INSTALLATION INSTRUCTIONS

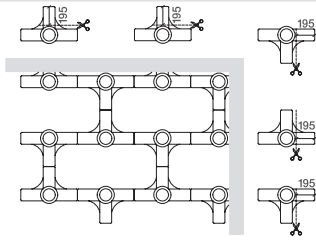

① Cut the bases as shown in the diagram and position the first row placing it against the wall. Proceed with the installation from right to left and from top to bottom.

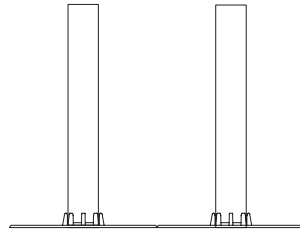
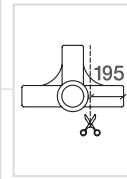

② Fit the PVC pipes into the bases applying some pressure on the top of the pipes in order to have a perfect coupling.

# CUATRO INSTALLATION INSTRUCTIONS

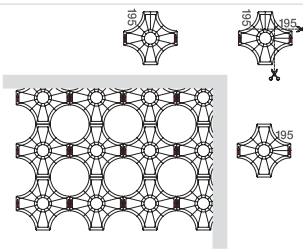

① Cut the bases as shown in the diagram and position the first row placing it against the wall. Proceed with the installation from right to left and from top to bottom.

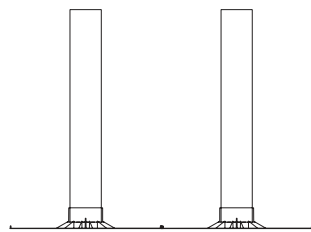
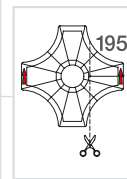

② Fit the PVC pipes into the bases applying some pressure on the top of the pipes in order to have a perfect coupling.

# MAX INSTALLATION INSTRUCTIONS

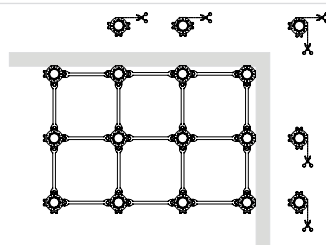

① Cut the bases as shown in the diagram and position the first row placing it against the wall. Proceed with the installation from right to left and from top to bottom.

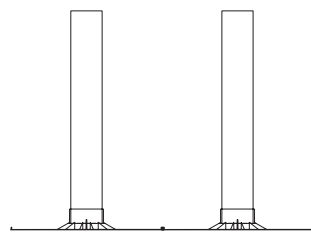
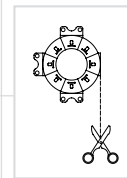

② Fit the PVC pipes into the bases applying some pressure on the top of the pipes in order to have a perfect coupling.



# PIPES AND FORMWORKS INSTALLATION INSTRUCTIONS

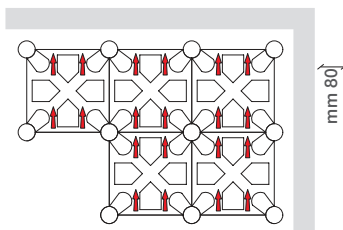

③ Install the Elevelor Tank forms making sure that they are perfectly coupled. Installation must be done from right to left and from top to bottom keeping the arrows marked on the formwork upwards.

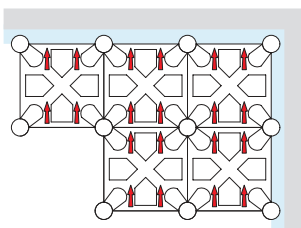

④ Fit the polystyrene strips between the exiting concrete walls and the forms

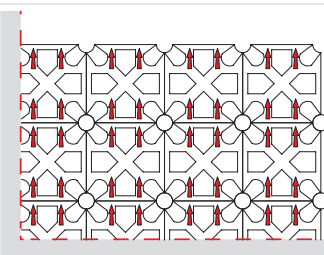

⑤ Place the last row of Elevelor Tank forms against the the walls and, if necessary, trim them to length.

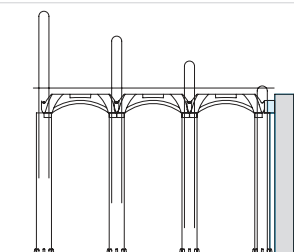
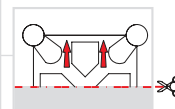

⑥ Lay the welded mesh reinforcement and the rebars in the legs, if required.

## INSPECTION PITS

Inspection pits simplify the control and maintenance of underground tanks.

The span between the legs allows access to tank, making it possible to operate for maintenance, repair or other activities. If necessary, it is possible to desing wider corridors.

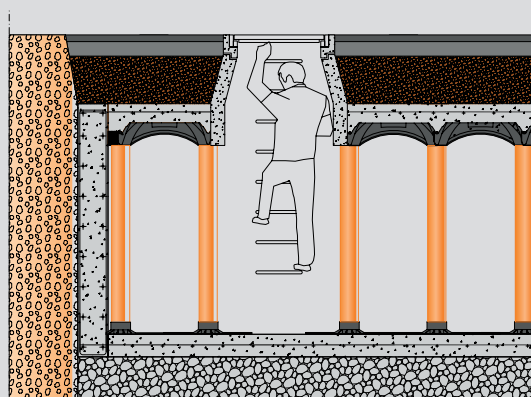

# RESIDENTIAL AND COMMERCIAL BUILDINGS

In order to prevent flooding in new developments and to comply with local regulations on the discharge into the sewage system, Elevator Tank makes it possible to create on-site cast reinforced concrete stormwater tanks.

Tanks can also be used for rainwater harvesting for the irrigation of gardens and lawns. All this with a view to sustainable use of the water resource.



# INDUSTRIAL BUILDINGS

Elevator Tank permits the construction of large size attenuation tanks, preventing potential flooding. The concrete structure can be sized for the heavy loads typical of logistic yards, and the high storage capacity also allows the use of the tank as a water reserve for production or fire-fighting purposes.



# INFRASTRUCTURE AND ROADWORKS

Elevetor Tank can also be used to create rainwater containment and attenuation systems for road infrastructure, in order to prevent potential disruption to the road network.

The modular structure allows the integration of the system even in curves or irregularly shaped surfaces in a quick and easy way. The high load resistance allows installation in areas subject to heavy traffic.



# FIRE-FIGHTING TANKS

The properties of Elevetor Tank make it the ideal system for the construction of underground tanks in reinforced concrete for the accumulation of large volumes of water for fire protection. The system is flexible and can easily integrate a pump housing chamber.



# GEOCELL

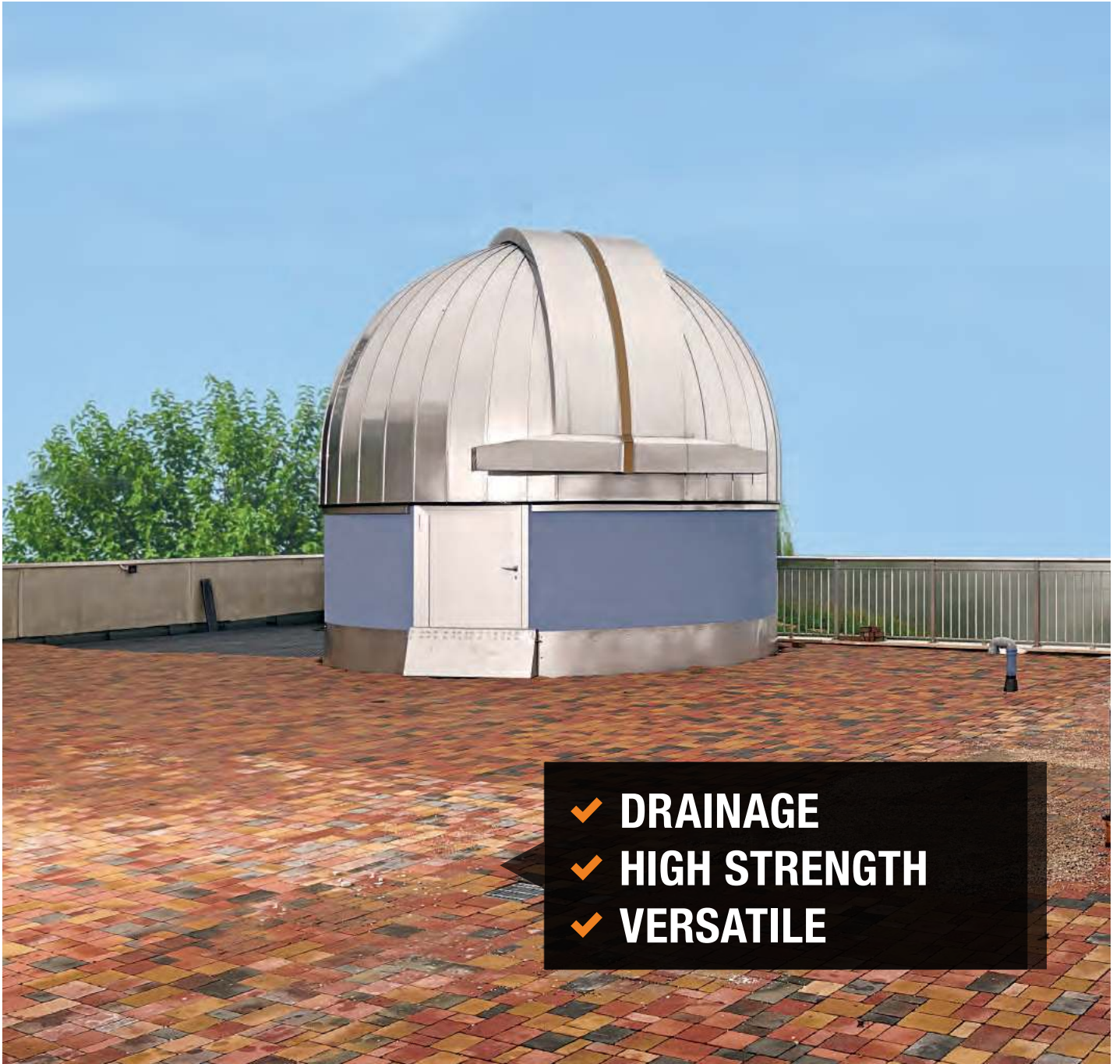

**DRAINAGE PANEL  
WITH HIGH HORIZONTAL  
FLOW RATE**

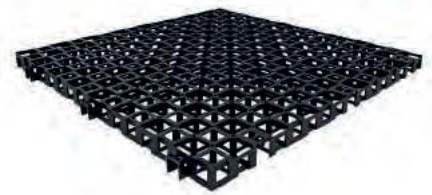

# THE SOLUTION

Geocell Geocell is a horizontal drainage panel made of regenerated PP used under paved or green surfaces.

Geocell solves the problems typically associated with interlocking pavers laid on a scarcely permeable base. By ensuring an effective and fast drainage, Geocell prevents saturation of the sand bedding layer, and the subsequent degradation of the paved surface due to lifting, especially if subjected to traffic.

The system is a considerable improvement in water flow capacity compared to traditional solutions, since it drastically shortens the time needed for rainwater evacuation. The thickness of a Geocell drainage system is thus considerably less than equivalent traditional systems.

## PAVED SURFACES

## SPORT COURTS

## GOLF COURTS

## GREEN ROOFS

## GEOTECHNICAL WORKS

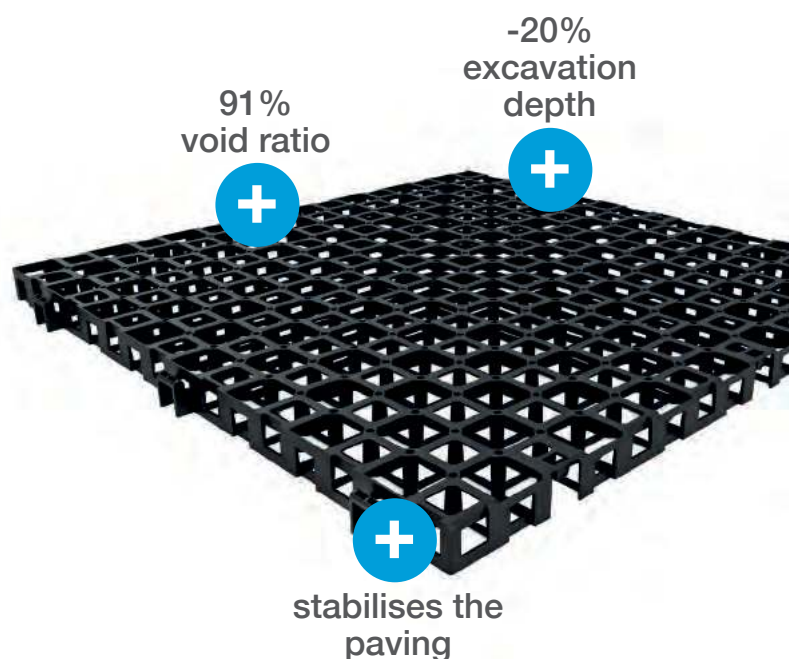

### TECHNICAL FOCUS

The depth of the different layers that make up the system may vary depending from the loads to which the area will be subjected. Of course the foundation layer must have corresponding structural characteristics.

As an indication, a total cover of 800 mm will accept heavy vehicle traffic (Meets the requirements of DIN1072 for load class SLW60).



# ADVANTAGES



Geocell is a high-strength grid made of regenerated polypropylene for wide-area water drainage underneath paved areas.

## **STRONG**

The specially engineered cellular structure gives Geocell a high flexural and compressive strength.

The ultimate rupture load is 95 t/m<sup>2</sup>: thanks to these properties it can be installed under areas with heavy traffic, thereby granting access to heavy vehicles as well.

## **VERSATILE**

Geocell can be used in different settings to effectively drain a variety of surface types.

The innovative coupling allows the elements to pivot up to an inclination of 90°, making it possible to follow variations in the substrate's course and give continuity to the drainage between vertical and horizontal surfaces.

## **HIGH FLOW RATE**

Thanks to the high void ratio of 91%, the Geocell drainage system is able to contain up to 27 litres of water per square metre of surface area.

This makes it possible to create a hollow space between the ground and the paving which is able to contain and drain away water from the substrate without it damaging the paving.

# THE CONCEPT

## LONGER IN-SERVICE LIFE

### CONVENTIONAL METHOD

Interlocking concrete paver surfaces risk decreasing their permeability to rainwater over time due to various factors (wear and tear, poor laying, water runoff effects, clogging).

This creates the conditions for water pooling and erosion of the sand bedding, which causes local subsidence as well as instability of the paving.



- greater depth of excavation;
- surface runoff and pooling;
- great risk of bedding saturation and erosion;
- instability of the interlocking paving;
- only vertical drainage.

### GEOCELL

Geocell creates a cavity beneath permeable paving surfaces, such as interlocking concrete pavers.

Thanks to its structure, Geocell improves vertical drainage performance, favouring the infiltration of rainwater into the subgrade, as well as a drastic increase of the horizontal drainage capacity.

The high compressive strength makes it suitable for trafficked surfaces.



- greatly reduced risk of bedding saturation;
- reduction of surface runoff;
- faster and more efficient drainage towards the canalisation;
- stability of interlocking pavers;
- high compressive strength under traffic loads.

# GEOCELL STRATIGRAPHY

INTERLOCKING  
CONCRETE PAVERS

SAND BEDDING

GEOCELL

GEOTEXTILE

AGGREGATE  
SUB-BASE COURSES

AGGREGATE  
FOUNDATION COURSE

GEOTEXTILE

NATURAL SOIL



## LAYING STAGES

- ① LAYING of lateral containment curbs;
- ② LAYING of geotextile at the bottom of the excavation;
- ③ LAYING of base courses;
- ④ LAYING of geotextile over base courses;
- ⑤ LAYING of GEOCELL over geotextile;
- ⑥ LAYING of geotextile over Geocell panels;
- ⑦ SPREAD sand bedding;
- ⑧ LAYING of interlocking pavers as designed,
- ⑨ FILLING of joints with sand;
- ⑩ VIBRO-COMPACTION of pavers;
- ⑪ FINAL FILLING of the joints.

*For further information please refer to the technical manual*



# LAYING



Geocell accepts any reasonably flat bedding. It is easy to lay as its coupling forgives slight unevenness. The modularity and the remarkable laying speed allow an agile and flexible workflow.

## COUPLING SEQUENCE

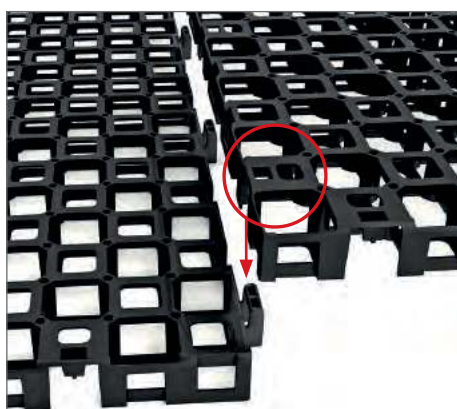

① Overlap

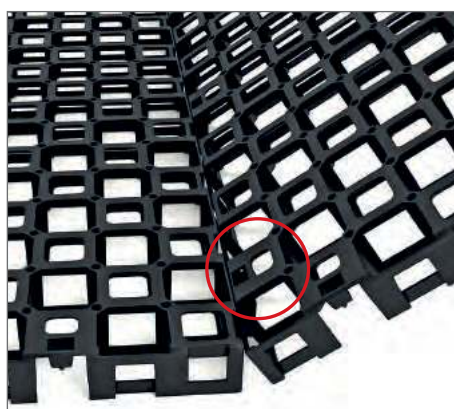

② Coupling



③ Pivoting up to 90°

Geocell is equipped with an innovative coupling that allows tilting of one panel with respect to the other up to a maximum inclination of 90°.

Even with the tilted panel the coupling ensures a stable connection of the elements.

**ESTIMATED LAYING TIME: 100 M<sup>2</sup>/MAN-HOUR**

# COMPARATIVE ANALYSIS

## TRADITIONAL METHOD

Soil permeability =  $10^{-7}$  m/s

Speed of infiltration =  $10^{-7}$  m<sup>3</sup>/s

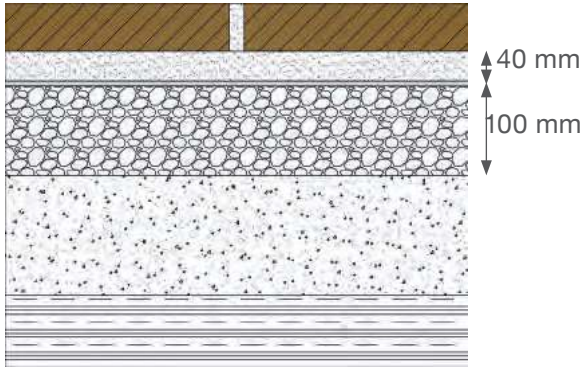

Storage volume of sand (100 mm) + sand (40 mm) =  $0,046 \text{ m}^3/\text{m}^2 = 46 \text{ mm}$   
 Emptying time =  $0,046 / 10^{-7} \approx 5,3 \text{ days}$

## GEOCELL

Soil permeability =  $10^{-7}$  m/s

Speed of infiltration =  $10^{-7}$  m<sup>3</sup>/s

Geocell drainage =  $0,004 \text{ m}^3/\text{s}$

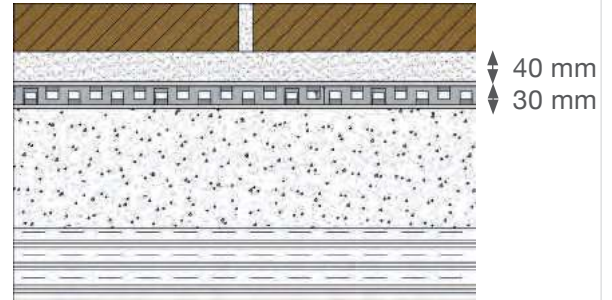

Geocell storage volume + sand (40 mm) =  $0,044 \text{ m}^3/\text{m}^2 = 44 \text{ mm}$   
 Emptying time =  $0,44 / (0,004 + 10^{-7}) < 1 \text{ h}$

## WITHOUT GEOCELL



## WITH GEOCELL

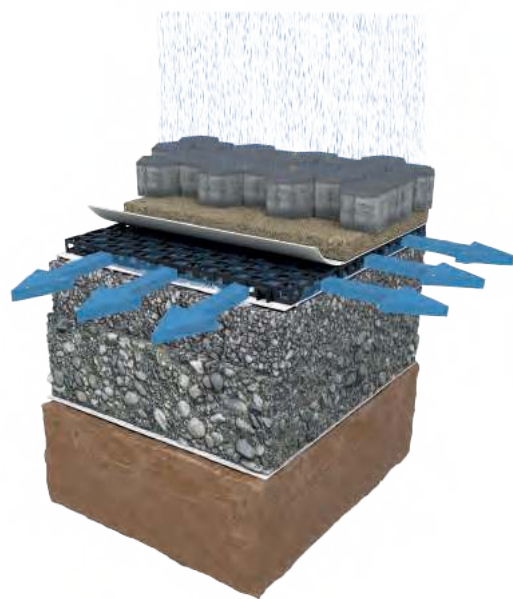

## VOID RATIO

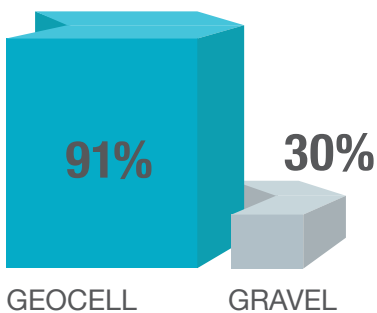

## DEPTH OF EXCAVATION

20% REDUCTION OF THE DEPTH OF EXCAVATION

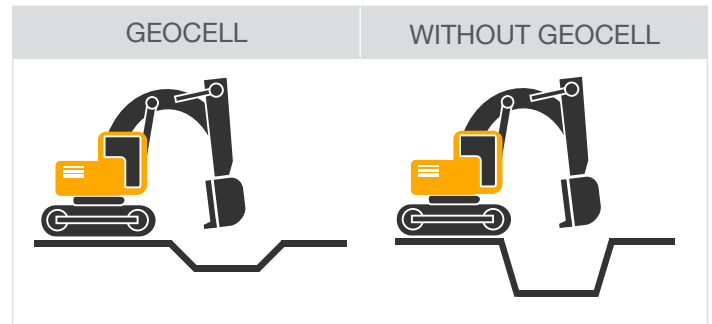

# INTERLOCKING PERMEABLE PAVERS

The cavity created by Geocell increases the drainage performance of the foundation course of permeable pavings. The element's structure provides drainage both in a vertical direction, favouring the infiltration of rainwater into the subsoil, and in a horizontal direction. In the case of poorly permeable soils, the available volume also produces a rainwater attenuation effect, allowing a gradual release of the water accumulated in the system. The high mechanical resistance enables it to be used also for heavy traffic areas and allows a significant reduction of the paving package.

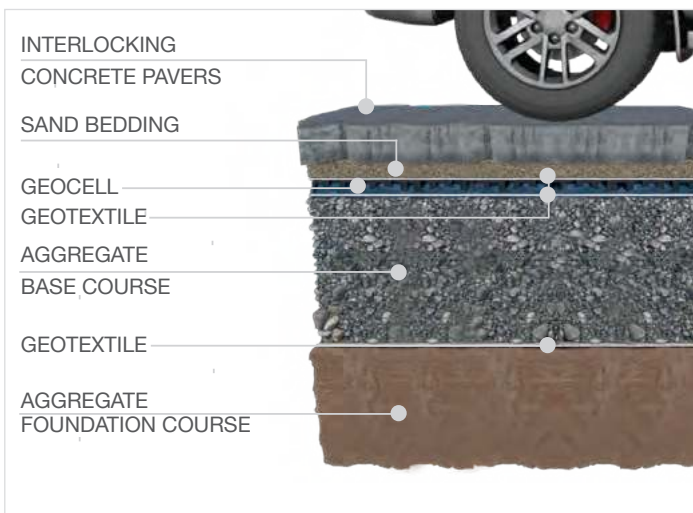

# SPORT COURTS

Geocell avoids water pooling on natural or synthetic grass sport surfaces, such as football pitches, 5-a-side football pitches, tennis courts or other sports installations.

The system creates a diffused rainwater drainage that allows the practice of sports even in wet weather situations without the performance being affected by the bad conditions of the ground, and allowing the surfaces to dry quickly. The high load-bearing capacity of Geocell also makes it possible to avoid the use of important thicknesses of gravel for the construction of the substrate.



# GOLF COURTS

Golf courses are an excellent example of Geocell's extensive rainwater drainage capacity. It avoids the formation of water pockets, and thanks to the pivoting coupling, the product can be easily installed even in areas with variable, so as to follow the shape of the ground and maintain the configuration of the course as planned.



# GEOTECHNICAL WORKS

Geocell can be used to create horizontal or vertical drainage to protect foundations and walls against the ground. Geocell reduces the hydrostatic pressures of the ground and avoids the penetration of water inside the structures, protecting the waterproofing membrane. The great mechanical resistance of the geocellular structure effectively counteracts the lateral thrusts of the ground, maintaining the efficiency of the drainage system over time.

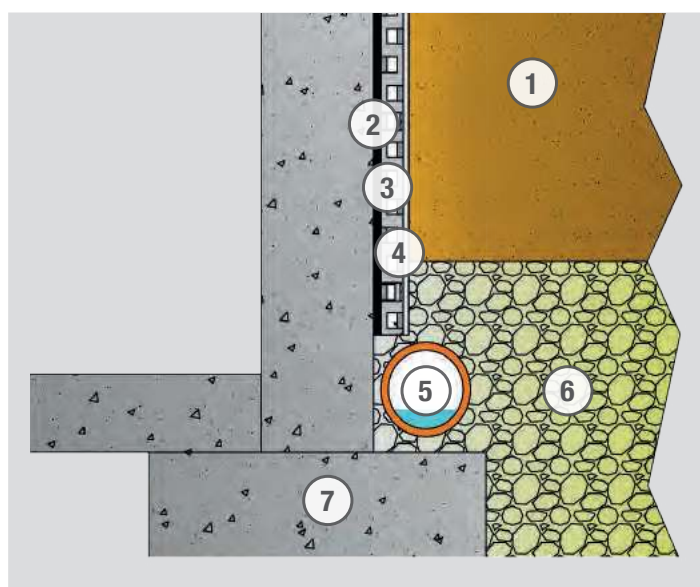
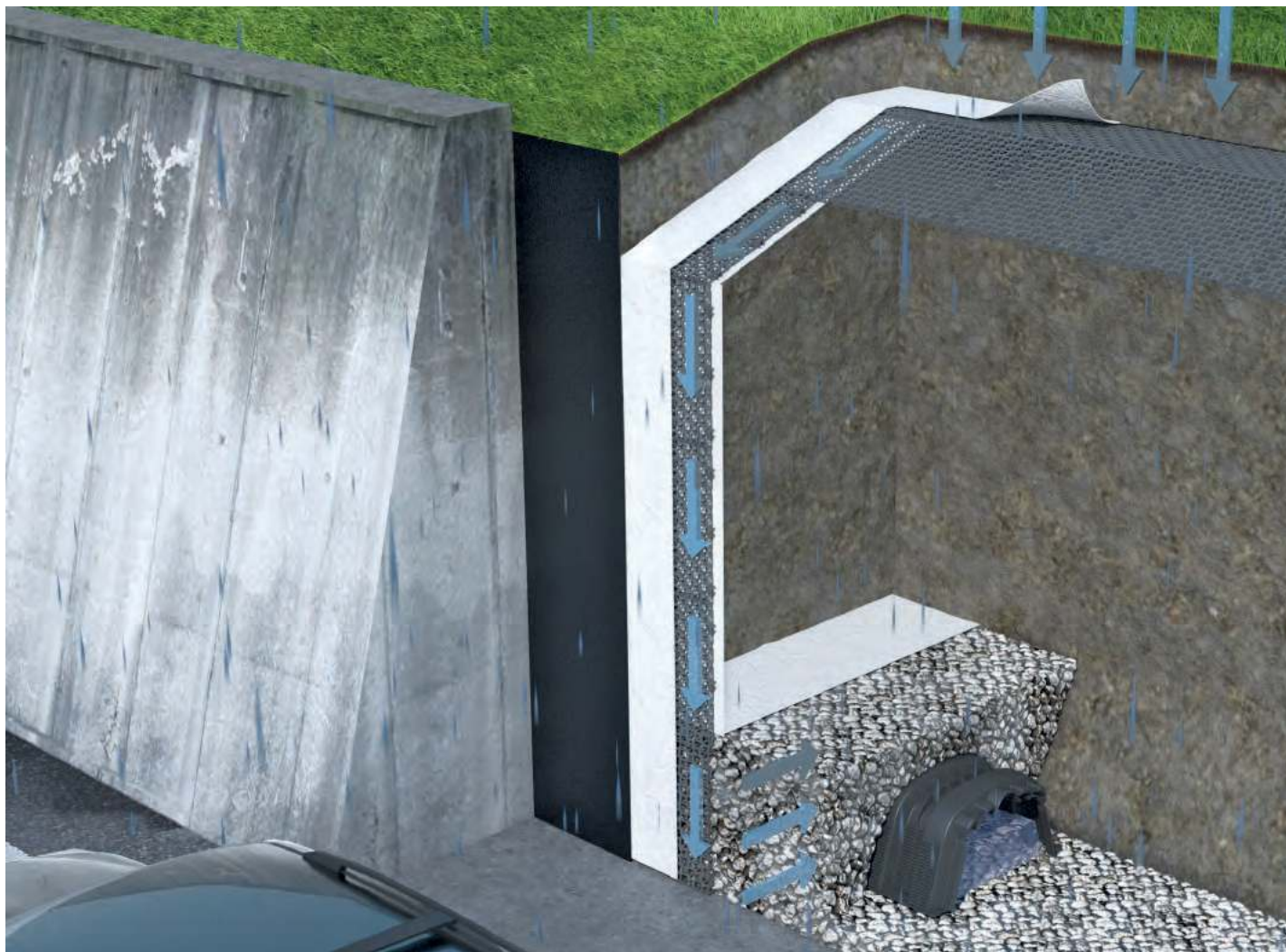

- ① NATURAL SOIL
- ② WATERPROOFING MEMBRANE
- ③ GEOCELL
- ④ GEOTEXTILE
- ⑤ MICRO-PERFORATED DRAINAGE TUBE
- ⑥ AGGREGATE
- ⑦ CONCRETE STRUCTURE

# DRENING TECHNICAL DATA



## DRENING

Dimensions (cm)	120 x 80 x H40
Length once installed (cm)	117
Material	Gralene HD Black / Graplene
Volume (l)	310
Lateral infiltration surface (cm <sup>2</sup> )	2.800
Package size (cm)	120 x 83 x H245
No. units per pallet	40
Product code	EDRENIN0040

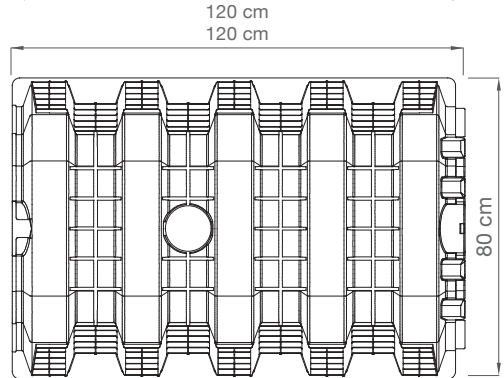
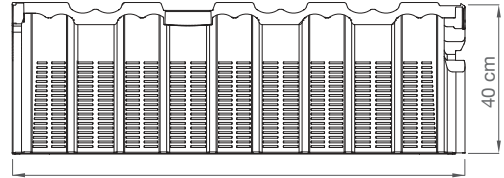

## DRENING CAP

Dimensions (cm)	70 x 40
Thickness	6
Material	Gralene HD Black / Graplene
No. units per pallet	100*
Product code	EDRTAPP0040

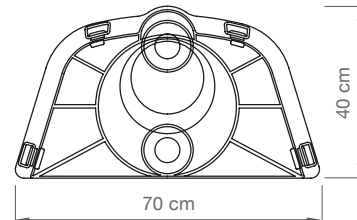

The Drenning Cap is compatible with tubes in the following diameters: ø 60, 110, 120, 200, 300, 320 mm.

\* Each pallet of Drenning can contain up to 10 pcs. Drenning cap.

# DRAINPANEL TECHNICAL DATA



## DRAINPANEL

Dimensions (cm)	112 x 112 x H23
Installed product height (cm)	20
Material	Graplene FV30
Nominal volume (m <sup>3</sup> )	0.25
Void ratio	96%
Package size (cm)	112 x 112 x H250
No. unites per pallet	75
Product code	EDRAINP0112

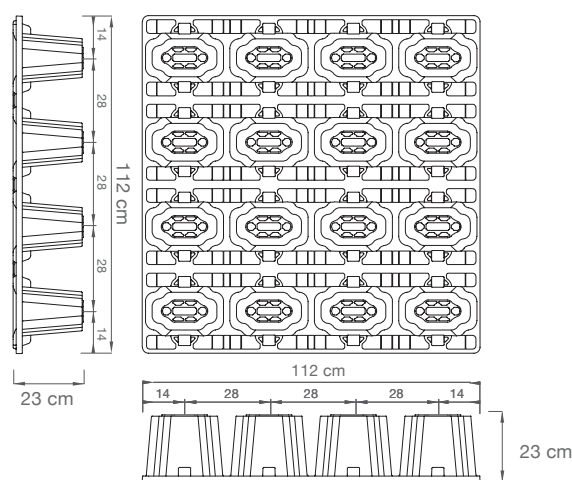

## DP-HALF

Dimensions (cm)	112 x 56 x H23
Installed product height (cm)	20
Material	Graplene FV30
Nominal volume (m <sup>3</sup> )	0.125
Void ratio	96%
Package size (cm)	112 x 112 x H250
No. unites per pallet	150
Product code	EDRAINP0056

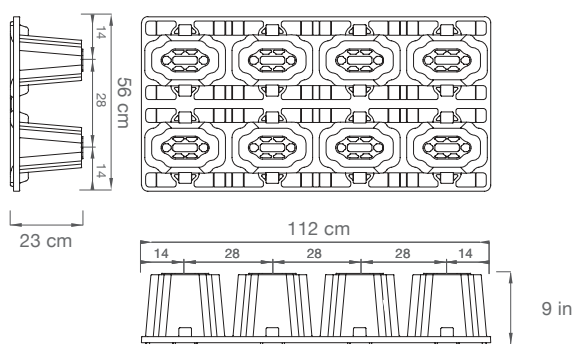

## DRAINPANEL GRID

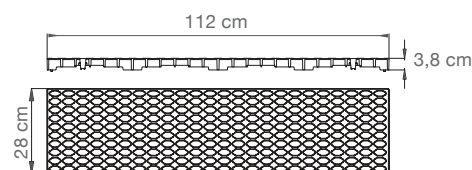

Dimensions (cm)	112 x 28 x H3,8
Material	Graplene FV30
Product code	EDRAING0028





# TECHNICAL DATA AQUABOX

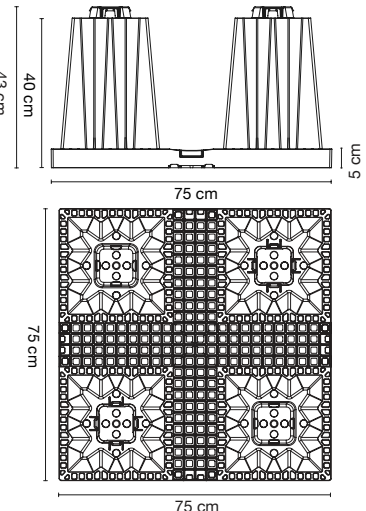

	AQUABOX HPR	AQUABOX HP	AQUABOX STR	AQUABOX ST
Dimensions (cm)	75 x 75 x H43			
Material	Graplene VNFV15	Graplene FV15	Graplene FV5	Graplene
Net storage volume (l/pcs)	216			
Void ratio	96%			
Package size (cm)	80 x 152 x H258			
No. pieces	80			
Product code	EDAQUVE1540	EDAQUFV1540	EDAQUFV0540	EDAQUAB0400

	SIDEWALL GRID HPR	SIDEWALL GRID HP	SIDEWALL GRID STR	SIDEWALL GRID ST
Dimensions (cm)	75 x 75 x H3,3			
Material	Graplene VNFV15	Graplene FV15	Graplene FV5	Graplene
Connection (DN/OD)	100, 110, 125, 160, 200, 225, 250, 315, 400, 500			
Package size (cm)	80 x 152 x H255			
No. pieces	140			
Product code	EDAQSWVE033	EDAQSWG033	EDAQSWF033	EDAQSWG0033

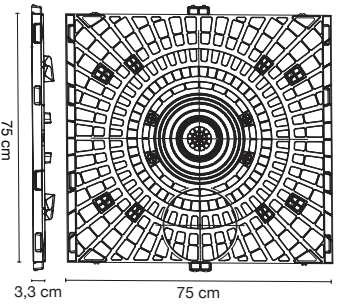
	HPR TOP CAP	HP TOP CAP	STR TOP CAP	ST TOP CAP
Dimensions (cm)	28,4 x 28,4 x H2,5			
Material	Graplene VNFV15	Graplene FV15	Graplene FV5	Graplene
Package size (cm)	90 x 120 x H255			
No. pieces	1200			
Product code	EDAQTFV1524	EDAQTOCV024	EDAQTFV0524	EDAQTOC0024



**Universal components for Aquabox and Aquabox Cube**

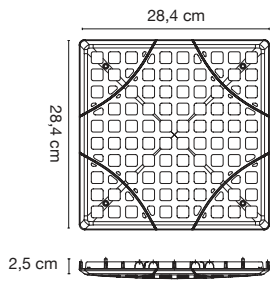

SINGLE JOINT	
Dimensions (cm)	12 x 7 x H3,5
Material	Graplene VN
Colour	Red
No. pieces per bag	400
Product code	EDAQJOI0035

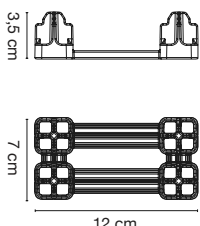

**Universal components for Aquabox and Aquabox Cube**



DOUBLE JOINT	
Dimensions (cm)	12 x 7 x H7
Material	Graplene VN
Colour	Red
No. pieces per bag	300
Product code	EDAQDOJ0070

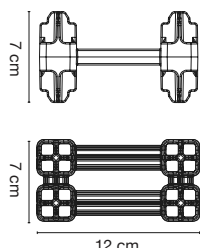



**Universal components for Aquabox and Aquabox Cube**





# TECHNICAL DATA AQUABOX CUBE

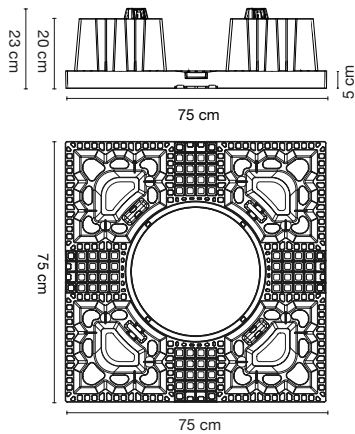

	<b>AQUABOX CUBE HPR</b>	<b>AQUABOX CUBE HP</b>	<b>AQUABOX CUBE STR</b>	<b>AQUABOX CUBE ST</b>
Dimensions (cm)	75 x 75 x H23			
Material	Graplene VNFV15	Graplene FV15	Graplene FV5	Graplene
Net storage volume (l/pcs)	106			
Void ratio	94%			
Package size (cm)	80 x 152 x H250			
No. pieces	88			
Product code	EDAQUVE0200	EDAQUBCV200	EDAQUFV0200	EDAQUBC0200



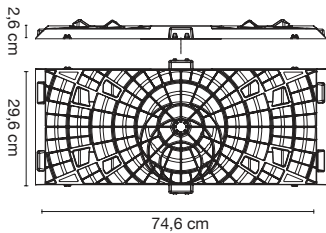



	<b>SIDEWALL GRID CUBE HPR</b>	<b>SIDEWALL GRID CUBE HP</b>	<b>SIDEWALL GRID CUBE STR</b>	<b>SIDEWALL GRID CUBE ST</b>
Dimensions (cm)	74,6 x 29,6 x H2,6			
Material	Graplene VNFV15	Graplene FV15	Graplene FV5	Graplene
Connection (DN/OD)	100, 160, 200			
Package size (cm)	85 x 120 x H260			
No. pieces	280			
Product code	EDAQUVE0026	EDAQSWG0026	EDAQUFV0026	EDAQSWG0026

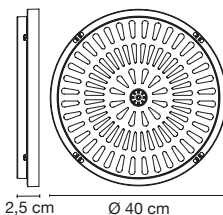

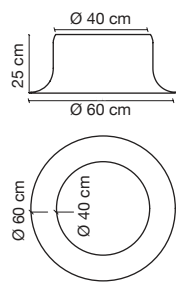

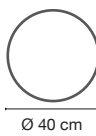
	<b>D4 HPR CAP</b>	<b>D4 HP CAP</b>	<b>D4 STR CAP</b>	<b>D4 ST CAP</b>
Dimensions (cm)	Ø40			
Material	Graplene VNFV15	Graplene FV15	Graplene FV5	Graplene
Package size (cm)	82 x 122 x H258			
No. pieces	312			
Product code	EDAQCVE0400	EDAQCCDV400	EDAQUFV0400	EDAQCCD0400



	<b>D4 CONNECTOR</b>			<b>O-RING</b>	
Dimensions (cm)	Ø40 X H25		Dimensions (cm)	Ø40 x H3,7	
Material	Gratene Black		Material	Elastomer	
Colour	Black		Colour	Black	
Product code	EDCONND0040		Product code	EDGUARA0040	

# ELEVATOR TANK TECHNICAL DATA



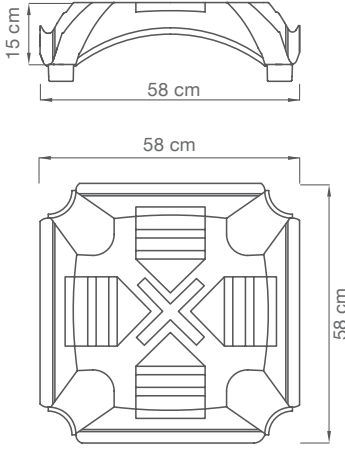

### MAX FORMWORK H15

Dimensions (cm)	58 x 58 x H15
Material	Graplene
Package size (cm)	120 x 120 x H265
No. pieces	225
Product code	EELEVEN858

# ELEVATOR MAX TECHNICAL DATA



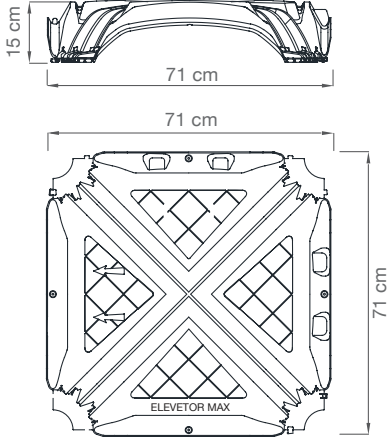

### ELEVATOR MAX FORMWORK

Dimensions (cm)	71 x 71 x H15
Material	Graplene
Package size (cm)	150 x 150 x H255
No. pieces	560
Product code	EELEMAX7171

# ELEVATOR TANK PRODUCT RANGE

### ELEVATOR TANK TRIO GRID



### ELEVATOR TANK CUATRO GRID



### ELEVATOR TANK MAX



# SYSTEM COMPONENTS



**TRIO BASE GRID**  
only for formwork 58 x 58

Dimensions (cm)	60 x 40
Material	Graplene
Package size (cm)	80 x 120 x H245
No. pieces	560
Product code	EELBAST5858



**CUATRO BASE GRID**  
only for formwork 58 x 58

Dimensions (cm)	58 x 58 x H2,5		
Material	Graplene		
Package size (cm)	110 x 110 x H250		
No. pieces	325		
Product code	EELBASE5858		



**BASE MAX**  
only for formwork 71 x 71

	Dimensions Ø int. cm 12,5	Dimensions Ø int. cm 16	Dimensions Ø int. cm 20
Material	Graplene		
Package size (cm)	100 x 120 x H245		
No. pieces	560		
Product code	EBASEMA7171	EBASEMA7171	EBASEMA7171



**PIPE**

	Thickness mm 1,8 / 2,0	Thickness mm 2,1 / 2,4	Thickness mm 2,5 / 2,8
Dimensions (cm)	75>200	75>200	75>200
Product code	EELTUBOXXXX	EELTUBSXXXX	EELTUBDXXXX



**SPACER**  
only for formwork 71 x 71

Dimensions (cm)	50 x 7
Package size (cm)	80 x 120 x H170
No. pieces	4400
Product code	EDISTEM7171



**LISTEL**

	Base cm 8	Base cm 9
Dimensions (cm)	11 x 150	11 x 150
Base Max	Ø 12,5 - Ø 16	Ø 20
Product code	EELLIST0150	EELLISS0150

# GEOCELL TECHNICAL DATA



**GEOCELL**

Dimensions (cm)	58 x 58 x H3
Material	Graplene
Storage capacity (l/m <sup>2</sup> )	27,6
Package size (cm)	120 x 120 x H240
No. pieces	300
m <sup>2</sup> per pallet	100
Colour	Nero
Permeability	99%
Product code	EGEOCEL5858

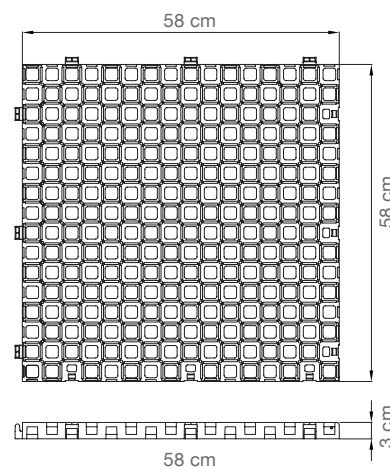

# PLANNING AND DESIGN IN INFILTRATION/ATTENUATION SYSTEMS

1

## DEFINITION OF COLLECTION AREAS

Green roofs, pedestrian areas, gardens, roundabouts, walkways, pavements and other urban surfaces are carefully assessed to establish the overall runoff and design the basin accordingly.

2

## SOIL EXAMINATION

Determination of the permeability of the soil based on its composition (kf value in m/s). The calculation must be as precise as possible to avoid flooding, structural failure or water infiltration in unsuitable areas.

3

## RETURN PERIOD

An infiltration or detention system is designed according to weather events, which may occur over a given period of time. This period of time is always established by the norms and regulations of the country or territory where the installation will be made and may vary from 5 to 100 years.

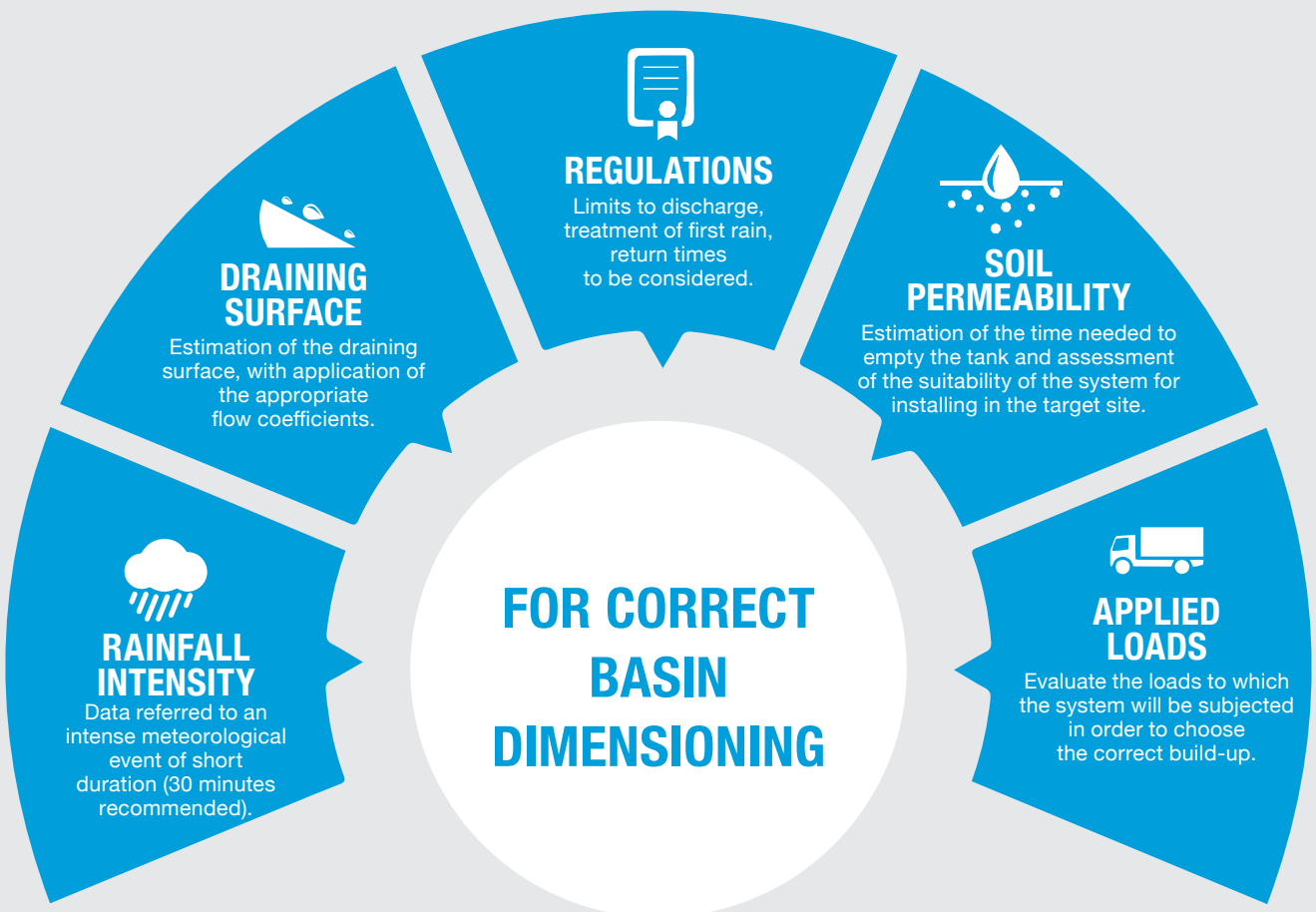

# PRELIMINARY DIMENSIONING

The dimensioning method of a rainwater harvesting tank is quite simple, and it is fundamentally based on the calculation of a volume of water entering the tank in a given period of time  $t$ , from which is subtracted the volume of water in out of the tank at the same time  $t$ .

Given the rainfall duration  $t$  the maximum value of  $V_{ACC}$  is calculated with the formula:

$$V_{ACC} = V_{IN} - V_{OUT}$$

The volume of rain that has to be drained by the system is calculated with the formula

$$V_{IN} = S \times p \text{ [m}^3\text{]}$$

where  $p$  is the rainfall in mm (which depends on the rainfall frequency and intensity of the area, publicly available data), and  $S$  which is the draining surface, which depends on the type of surface on which the rain falls, whose characteristics affect the amount of water that reaches the tank.

The draining surface is calculated with:

$$S = \sum_i S_i \times \Phi_i = S_1 \Phi_1 + \dots + S_n \Phi_n$$

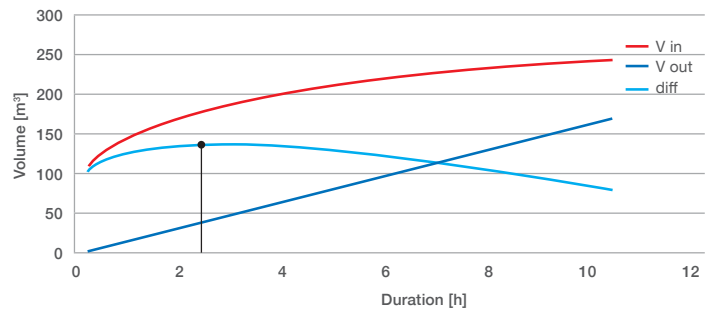

TYPE OF SURFACE	
Roofs covered with sheet metal or tiles	0,9 ÷ 10
Flat roofs with concrete surface	0,7 ÷ 0,8
Flat roofs and green roofs	0,3 ÷ 0,4
Paved surfaces	0,7 ÷ 0,9
Dirt roads	0,4 ÷ 0,6
Grass surfaces	0,1 ÷ 0,4
Residential areas	0,3 ÷ 0,7
Woodland	0,1 ÷ 0,3
Cultivated land	0,2 ÷ 0,6

# OUR CONSULTING SERVICES

The Geoplast website provides full documentation to give concrete technical support to planners, designers and builders.

The Geoplast website provides documents in PDF format and CAD files in DWG format, as well as BIM files. Moreover, designers and/or engineers can compare and share project information with the Geoplast technical department, that will be happy to carry out feasibility and dimensioning analyses of rainwater harvesting/infiltration systems.

## GeoplastGlobal.com

PDF and DWG documents

BIM documents

Calculation software

# REFERENCES

## DRENING, NEW DEVELOPMENT, MILAN, ITALY

Multiple Drening infiltration systems were installed in a new residential centre to handle a rainwater volume of approximately 450 cubic metres.



## DRAINPANEL, NEW SEA VISION HQ, PAVIA, ITALY

The Drainpanel modules were installed underneath the employee car park at SEA Vision's new headquarters. The construction of a 1000 cubic metre infiltration basin allowed for the proper management of rainwater from the flat roof.



# REFERENCES

## AQUABOX, ORIO AL SERIO AIRPORT, BERGAMO, ITALY

The use of the Aquabox modular system provided the full drainage of the Milan/Bergamo Orio al Serio airport runway with a tank capable of containing 800 cubic metres of rainwater.



## ELEVATOR TANK, SHOPPING MALL, MARGHERA, ITALY

Elevator Tank was used to build a rainwater storage tank underneath the customer car park of the “Nave de vero” shopping centre in Marghera, near Venice. The reinforced concrete tank holds 5000 cubic metres of water.



# REFERENZE

## DRENING, RESIDENTIAL DISTRICT, ALESSANDRIA, ITALY

The 4 tanks made with Drening, have allowed to temporarily collect rainwater coming from the roofs, the squares and the streets of the new residential district, thus avoiding the discharge into the existing sewerage system, considered undersized by the designer.



## GEOCELL, PEDESTRIAN TERRACE OBSERVATORY, VICENZA, ITALY

The Geocell system significantly improved the stormwater runoff capacity, drastically shortening the drainage time and at the same time reducing the thickness of the drainage package compared to traditional systems.

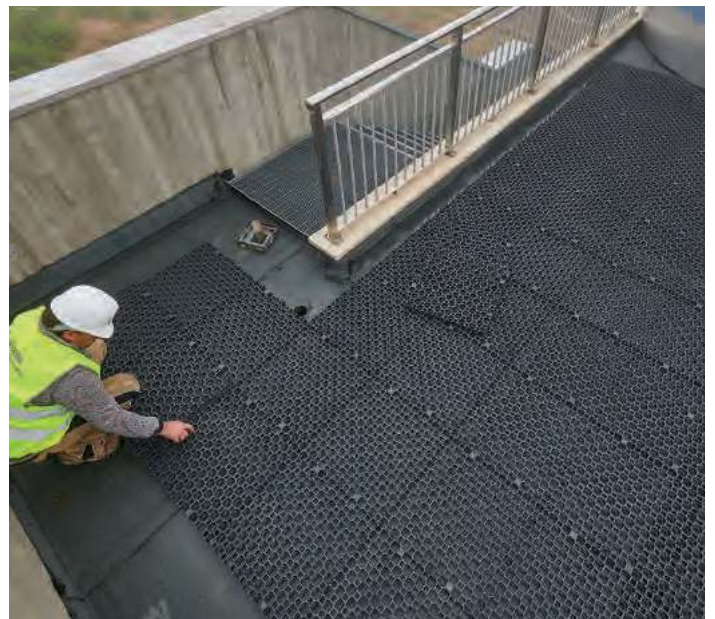



# REFERENZE

## ELEVATOR TANK, FIRE AND EMERGENCY CENTRE, SAINT-LAURENT-DU-VAR, FRANCE

The area of Saint-Laurent-du-Var, near Nice in France, is steep and highly urbanised. The new fire station had a limited surface area available: Elevator Tank made it possible to build a fire water tank underneath the building itself. This optimised the use of the available surface area, without compromising the functionality or solidity of the structure.



## AQUABOX, BUSINESS CENTRE, MILAN, ITALY

Infiltration tank made with Aquabox were used to manage rainwater from the roof and the surrounding forecourt in the new business centre complex. Aquabox was chosen for its great versatility and ease of handling and installation on site.



# GLOBAL PROJECTS

I prodotti della divisione Acqua di Geoplast migliorano la resilienza urbana. Le nostre soluzioni includono le trincee drenanti e di laminazione per la gestione delle acque meteoriche, vasche di accumulo e stoccaggio dell'acqua piovana e sistemi per lo smaltimento delle acque reflue.



**ELEVATOR TANK**  
MondoJuve shopping mall  
TORINO, ITALY



**DRENING**  
Marchesini Group HQ  
PARIS, FRANCE



**DRAINPANEL**  
Allianz Cloud Sport Hall  
MILAN, ITALY



**DRAINPANEL**  
University Campus  
FERRARA, ITALY



**DRAINPANEL**  
Sea Vision headquarter  
PAVIA, ITALY



**ELEVATOR TANK**  
Firefighting center  
SAINT-LAURENT-DU-VAR, FRANCE



**DRAINPANEL**  
Private rehab center  
BOLOGNA, ITALY



**AQUABOX**  
Orio al Serio airport  
BERGAMO, ITALY



**Geoplast**  
Building beyond together

Geoplast S.p.A.

Via Martiri della Libertà, 6/8  
35010 Grantorto (PD) - Italy

Tel +39 049 9490289

Fax +39 049 9494028

Geoplast@Geoplastglobal.com

GeoplastGlobal.com



REV. 0001\_05/2021

